



Silhouette v4.1

## **Clinical User's Guide**

Note: This device is developed for use only by qualified medical professionals trained and experienced in its use. Do not use the device before reading and understanding this user's guide.

This document has been prepared by ARANZ Medical Limited for its customers. The content of this document is confidential. It may be reproduced only with written permission from ARANZ Medical Limited. Specifications contained herein are subject to change, and these changes will be reported in subsequent revisions or editions. The device described in this document cannot substitute for the knowledge, skill and experience of the competent medical personnel who are its intended users. Its use as such a substitute is prohibited.

**Copyright © 2017 ARANZ Medical Limited**

All rights reserved. Unauthorized use, reproduction, or disclosure is prohibited. Patents pending. No patent liability is assumed with respect to the use of the information contained herein. While every precaution has been taken in the preparation of this user's guide, ARANZ Medical assumes no responsibility for errors or omissions. Neither is any liability assumed for damages resulting from use of the information contained herein.



ARANZ Medical Limited

Tel +64-3-374 6120, Fax +64-3-374 6130

47 Hereford Street  
Christchurch 8013  
New Zealand

CE Authorised Representative  
mdiEUROPA  
Phone +49 (0)511 39089530  
werner.sander@mdi-europa.com  
Langenhagener Str. 71  
30855 Langenhagen

FDA Authorised Representative  
MDI Consultants  
Phone +1 (516) 482 9001  
alan@mdiconsultants.com

TGA Sponsor #55050  
Brandwood Biomedical Pty Ltd  
Phone +61 (0) 2 9906 2984  
help@brandwoodbiomedical.com

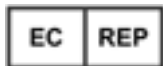

ARANZ Medical Limited documentation often refers to hardware or software products by their trade names. In most, if not all, cases these designations are claimed as trademarks or registered trademarks of their respective companies. The trade names are used here for identification purposes only.

Document Number: 2017-00468 Rev2.0

# Contents

---

<b>Introduction</b> .....	<b>1</b>
System Description .....	1
The Organization of Patient Data .....	2
Guide Topics .....	3
<b>Using the SilhouetteStar Camera</b> .....	<b>4</b>
Topics .....	4
SilhouetteStar Wound Imaging Workflow .....	5
Logging In to SilhouetteCentral .....	5
Select a Patient .....	6
Connecting the SilhouetteStar 2 using Wi-Fi .....	6
Take Wound Images .....	8
Create an Assessment .....	8
Capturing Quality Images with the SilhouetteStar .....	12
The Mathematics of the SilhouetteStar's Measurements .....	12
Lighting Requirements for Image Capture .....	12
Holding the SilhouetteStar and Positioning the Lasers .....	12
Preferred Laser Positioning .....	13
Acceptable Laser Positioning for Large Wounds .....	14
Preferred Laser Positioning for Wounds Containing Islands .....	14
Preferred Laser Positioning for Wounds With Multiple Outlines .....	14
Poor Laser Positioning .....	14
Taking a Multiple Image Measurement .....	16
The SilhouetteStar Camera .....	18
SilhouetteStar Components .....	18
Top View .....	18
Bottom View .....	19
Side Views .....	19
The SilhouetteStar 2 Display .....	20
Display States .....	20
SilhouetteStar Button Modes .....	21
Resetting SilhouetteStar 2 .....	22
SilhouetteStar 2 Battery Management .....	22
Disconnecting the Camera .....	22
SilhouetteStar Label Information .....	23
SilhouetteStar Warnings .....	25
Laser Warnings .....	25
Other Warnings .....	25

---

Care of the SilhouetteStar .....	27
Cleaning the SilhouetteStar .....	27
<b>Using SilhouetteLite+ .....</b>	<b>29</b>
Topics .....	29
SilhouetteLite+ Wound Imaging Workflow .....	30
Select or Create a Patient in SilhouetteLite+ .....	30
Select the Assessment Type .....	31
Select or Create the Wound to Assess .....	31
Performing an Assessment in SilhouetteLite+ .....	31
Using Image Capture Fields .....	32
Using Notes Fields .....	36
SilhouetteLite+ Guidelines for Use .....	36
The SilhouetteLite+ Sensor .....	38
SilhouetteLite+ Label Information .....	38
SilhouetteLite+ Warnings .....	39
Laser Warnings .....	39
Other Warnings .....	39
Care of the SilhouetteLite+ Sensor .....	40
Cleaning the SilhouetteLite+ sensor .....	40
Setting Up SilhouetteLite+ .....	42
Download the SilhouetteLite+ App .....	42
Unbox the SilhouetteLite+ Sensor .....	42
Charging the SilhouetteLite+ Sensor .....	43
Attach the SilhouetteLite+ Sensor to Your Device .....	44
Setup the SilhouetteLite+ App .....	45
Changing SilhouetteLite+ Settings .....	46
<b>Using SilhouetteLite .....</b>	<b>50</b>
Download the SilhouetteLite App .....	50
Setup SilhouetteLite .....	50
Select or Create a Patient in SilhouetteLite .....	51
Perform an Assessment in SilhouetteLite .....	52
Changing SilhouetteLite Settings .....	52
<b>The Silhouette Clinical UI .....</b>	<b>55</b>
Topics .....	55
Parts of the User Interface .....	56
Navigation .....	56
The Application Menu .....	56
The Toolbar .....	57
The Sidebar .....	57

---

Version .....	57
Return to Patient List (Home) .....	57
Selecting Items .....	57
Workflow .....	57
The Patient Selection Screen .....	59
Creating a New Patient .....	60
The Patient Dashboard .....	61
Patient Summary .....	61
Sidebar .....	61
Patient Timeline .....	62
Assessments .....	64
New Patient Level Assessment .....	65
Share Button .....	65
Wounds .....	66
Wound Dashboard .....	66
Measurements .....	67
New Wound Assessments .....	68
Assigning SilhouetteStar Captured Images .....	68
Wound Images .....	70
Tracing Wound Outlines .....	72
<b>The SilhouetteCentral Admin UI .....</b>	<b>78</b>
Profile .....	79
Changing Your Password .....	80
<b>System Requirements and Operating Conditions .....</b>	<b>81</b>
SilhouetteCentral Web Application - Minimum Requirements .....	81
SilhouetteStar 2 - Minimum Requirements .....	81
SilhouetteLite and SilhouetteLite+ App - Minimum Requirements .....	82
SilhouetteLite+ Sensor - Operating Conditions .....	82
<b>Troubleshooting .....</b>	<b>84</b>
Recovering Forgotten Password .....	85
Troubleshooting SilhouetteLite+ .....	87
<b>CTEULA and Terms of Use .....</b>	<b>88</b>
ARANZ Medical Limited – Silhouette® Product Suite Terms of Use .....	92

## Introduction

This clinical user's guide describes how to use Silhouette™ for capturing images of wounds, making wound measurements, and documenting healing progress over time. It describes how to use the clinical features and functions of the Silhouette system.

The Silhouette Admin and Silhouette Configuration manuals are available for non-clinical users.

### System Description

**SilhouetteCentral** is a computerized wound imaging, analysis, and documentation system. SilhouetteCentral enables users to review, report, securely share and analyze the wound data collected by SilhouetteStar 2, SilhouetteLite+ and SilhouetteLite applications. SilhouetteCentral is accessed via a web-based application.

SilhouetteCentral is divided into two parts:

- Clinical UI - Provides access to the patient medical data stored in the Silhouette database for reviewing, editing, and updating. Reports, images, and wound measurement data can also be exported for further processing and importing into other applications.
- Administration - Provides facilities to manage units, groups, patients, and system users. SilhouetteCentral can also be used to configure and customize the Silhouette system.

**SilhouetteStar 2** is a camera that captures wound images and non-contact 3D measurements of wounds at the point of care. The images and data captured with SilhouetteStar 2 are uploaded to SilhouetteCentral over a secure Wi-Fi network.

**SilhouetteLite+** is comprised of an application and a range finding sensor for Apple® iPhone®, iPod® touch and iPad® iOS 10+ devices. SilhouetteLite+ enables users to take wound images, obtain non-contact 2D measurements, and record patient notes on their mobile device. The data collected at the patient's bedside is synchronized with SilhouetteCentral over a secure connection when available.

**SilhouetteLite** is an application designed for Apple® iPhone®, iPod® touch and iPad® iOS 10+ devices. SilhouetteLite is a simplified application that enables users to add patients, wound images and simple notes (without measurements) to SilhouetteCentral. The data collected at the patient's bedside is synchronized with SilhouetteCentral over a secure network connection when available.

### The Organization of Patient Data

In Silhouette, the region of interest that is assessed is the wound. For each patient, each wound is designated with an identifying label, starting with the letter A or the number 1 (as defined in Settings). Once assigned, the identifying label for a particular wound does not change.

Information about the patient that isn't likely to change encounter to encounter is captured as patient information. Information that is captured about the current state of the patient or of a particular wound is organized into assessments, either patient assessments or wound assessments:

- A patient assessment contains all the information collected during the patient's appointment with the healthcare provider, such as health condition of the patient and other overall details.
- A wound assessment is made for each wound and contains all the information collected about a particular wound, at that point of time. This information includes images, measurements, and notes specific to a single wound being assessed.

If a wound needs to have another measurement taken during an appointment, such as pre- and post-debridement, then the second measurement will be contained in a second assessment.

[The Patient Dashboard](#) summarizes information about a single patient, such as:

- The **Patient Summary** shows all of the high level information for the patient.
- The **Wounds** shows all wounds defined for the patient.
- The **Sidebar** contains links to the patient **Details** and **Notes** as well as a list of **Wounds** defined for the patient.
- The **Patient Timeline** shows the assessments that have been made on the patient, some of these assessments may be of particular wounds. Images and wound summary information are shown where appropriate.

## Guide Topics

This user's guide is divided into the following high level topics:



[Using the SilhouetteStar Camera](#)



[Using SilhouetteLite+](#)



[Using SilhouetteLite](#)



[The Silhouette Clinical UI](#)



[The SilhouetteCentral Admin UI](#)



[System Requirements and  
Operating Conditions](#)



[Troubleshooting](#)



[CTEULA and Terms of Use](#)



## Using the SilhouetteStar Camera

**SilhouetteStar 2** is a camera that captures wound images and non-contact 3D measurements of wounds at the point of care. The images and data captured with SilhouetteStar 2 are uploaded to SilhouetteCentral over a secure Wi-Fi network.

This section of the guide describes the SilhouetteStar camera and how it is used to capture wound images and measurements in Silhouette.

### Topics



[SilhouetteStar Wound Imaging Workflow](#)



[Capturing Quality Images with the SilhouetteStar](#)



[The SilhouetteStar Camera](#)

## SilhouetteStar Wound Imaging Workflow

This section of the guide describes the main workflow to capture a wound assessment with the SilhouetteStar 2 in wireless mode with SilhouetteCentral.

1. [Logging In to SilhouetteCentral](#)
2. [Select a Patient](#)
3. [Connecting the SilhouetteStar 2 using Wi-Fi](#)
4. [Take Wound Images](#)
5. [Create an Assessment](#)

See "[The Silhouette Clinical UI](#)" for more detailed instructions.

### Logging In to SilhouetteCentral

To log in to SilhouetteCentral, navigate to the website address of your SilhouetteCentral instance. The log on screen will appear. Enter the **User Name** and **Password** supplied to you. Select **Login**.



The image shows a login form with two text input fields. The first field is labeled 'User Name' and the second is labeled 'Password'. Below the 'User Name' field is a blue button with the text 'Login'. To the right of the 'Password' field is a blue link with the text 'Forgot your password?'.

It is important to log on using the **User Name** and **Password** assigned to you. Silhouette records the names of users viewing, creating, and modifying patient records, and using the correct user name ensures accurate auditing.

Many browsers will prompt you to save a **User Name** and **Password** for websites you log on to. If using a shared computer, it is recommended that you do not permit the browser to save your login detail for SilhouetteCentral. Doing so means that anyone using your computer can log on, access and potentially modify patient medical records that will be recorded as having been actioned by you.

While logging on to SilhouetteCentral you may occasionally be prompted to change your password if a system administrator has made use of the password expiry features. In this case you will need to pick a new password that meets the password complexity requirements and enter it before Silhouette will allow you to log on.



If you are having trouble logging in then use the **Forgot your password?** link to reset your password, [See "Recovering Forgotten Password"](#).

## 6 • Select a Patient

### Select a Patient

The patients available in the system are shown in a series of tiles.

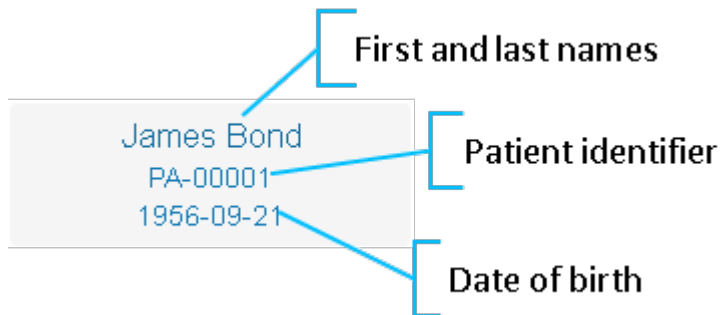

Use the **search** box to find a patient. The search facility searches the following patient details:

- First name
- Middle name
- Last name
- Patient ID

When searching, the search looks for matches starting at the beginning of any field. For example, entering an M into the search box will find Mary but not Amy.

If there are too many patients to display on one screen then the **Load More** button will be available to show more patients.

Once you have found the patient you want to select then select the patient tile to select that patient and view the patient dashboard.



If the patient doesn't exist in Silhouette, then you may be able to create the patient ([See "Creating a New Patient"](#)).



You can return to the patient search and select screen at any time by selecting the patient search icon or the Silhouette logo in the top left of the screen.

### Connecting the SilhouetteStar 2 using Wi-Fi

The SilhouetteStar 2 can be connected to SilhouetteCentral through a Wi-Fi connection, using the following process:

1. Push the button on the SilhouetteStar 2 to turn the camera on. The camera displays a kiwi bird walking while it is starting up.



Once the camera is started and ready to go the SilhouetteStar 2 screen displays instructions to Please Connect.



2. Once you are logged in to SilhouetteCentral with a patient selected, use the **camera icon** () in the patient sidebar to open the image portfolio and the connection QR Code.

 If the QR Code is not visible then use the link *Connect the SilhouetteStar* to show it.

3. Press the button on the SilhouetteStar 2 to turn the guide lasers on and point the lasers towards the on-screen QR Code.

 The QR Code contains encrypted connection information allowing the camera to connect to the Wi-Fi and to select the correct patient.

When the camera has decoded the QR Code the camera screen will show connecting and the Wi-Fi strength icon will be shown.



Once the camera is connected successfully then the selected patient's name, ID and date of birth appear on the camera screen for positive identification.

## 8 • Take Wound Images



The SilhouetteStar 2 camera is now ready to take wound images.

### Take Wound Images

To take wound images:

1. Press the button on the camera to turn the lasers on.
2. Point the camera at the wound so that the lasers form a star in the wound and at least one laser crosses the deepest part of the wound.
3. Press and release the button on the camera to take an image. Hold the camera steady while the image is being captured.
4. Once an image is captured, the camera will show a camera icon (  ) to indicate images are uploading to SilhouetteCentral. More images can be taken while previous images are uploading.

[See "Capturing Quality Images with the SilhouetteStar"](#) for more information about capturing images.

### Create an Assessment

To create a wound assessment to include images from the SilhouetteStar:

1. Add the captured image(s) to create a wound assessment in SilhouetteCentral.
  - a. Close the image portfolio using the **close** button.
  - b. Select the wound that has been imaged by selecting the **wound label** in the patient sidebar. If it is a new wound then create a new wound using the **+** button in the patient sidebar.

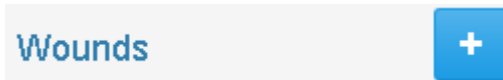

- c. Create an assessment using the **+** button at the top of the wound timeline.

**Wound Timeline**



- d. Select the **+** sign in the image field you wish to assign images to bring up the image portfolio.



- e. Select the images you wish to add to the assessment by clicking or touching them.
  - f. Close the image portfolio using the **close** button and the images will now show assigned to the assessment.
2. Trace the image to take wound measurements.
- a. Select the image you wish to trace.
  - b. Move the on-screen pencil to the edge of the wound. Move the pencil without drawing by using a dragging motion, rather than a select and hold motion.
  - c. Select the **pencil** and holding it in one spot to start the tracing (a dot with a finish target will appear on the screen to indicate the tracing has started).
  - d. Move the **pencil** around the wound in one direction until the finish target is reached. Once the outline tracing has begun, moving the **pencil** will continue the tracing until the wound boundary is complete, i.e. the **pencil** is moved back to the start of the tracing.
  - e. Use the tools below to make edits as required.

## 10 • Create an Assessment

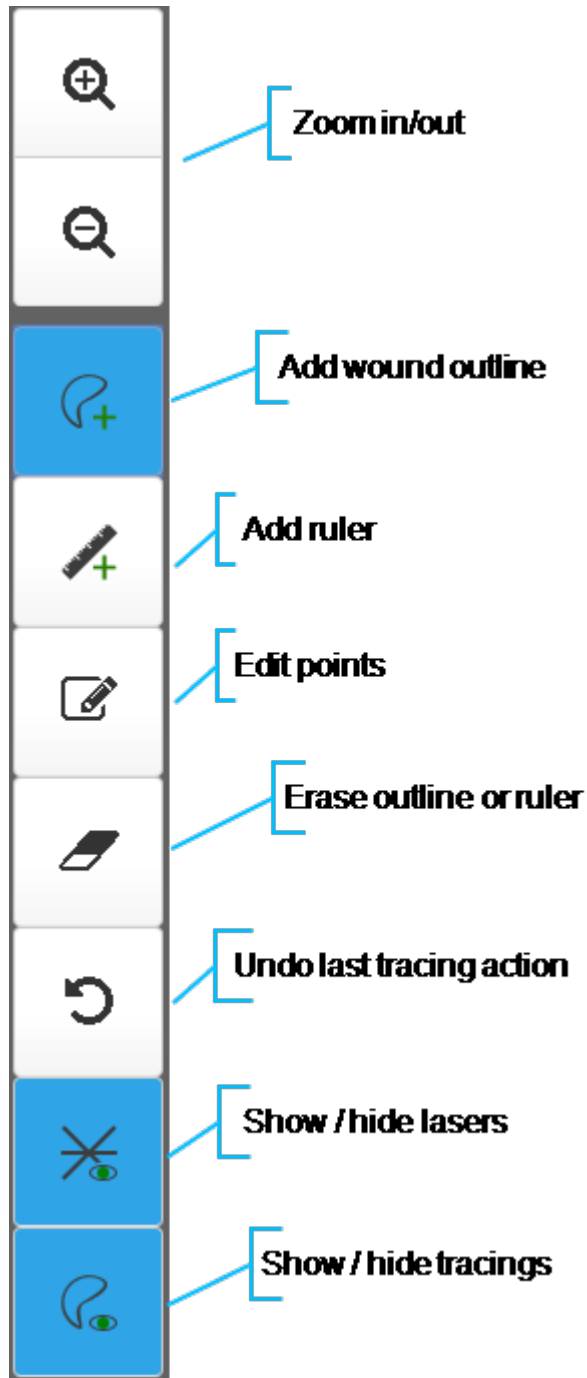

- f. Once all tracing is complete apply the tracing using the **Apply** button.
  - g. Measurements from the wound tracing appear under the images in the assessment.
3. Add any notes you wish to capture into the notes fields and then **Save** the assessment.
  4. Once the assessment is saved you can:
    - Select the **Share** button to generate a PDF report of the assessment.
    - Select the **Edit** button to edit the assessment data or adjust tracings on images.

- Select the **wound label** in the patient sidebar to see the wound dashboard and the measurements from this assessment in the wound graph.



## Capturing Quality Images with the SilhouetteStar

This section describes:

- [The Mathematics of the SilhouetteStar's Measurements](#)
- [Lighting Requirements for Image Capture](#)
- [Holding the SilhouetteStar and Positioning the Lasers](#)
- [Taking a Multiple Image Measurement](#)

### The Mathematics of the SilhouetteStar's Measurements

SilhouetteStar projects laser lighting onto the body surface in order to gain 3D information about the wound and surrounding tissue. SilhouetteStar consists of:

- Three lasers
- White LEDs for illuminating the body surface
- A digital camera for capturing the image

SilhouetteStar connects to your computer using one of its USB ports or through a wireless Wi-Fi connection. Images captured using SilhouetteStar are displayed in Silhouette, where you can outline the wound boundary and make surface area, depth, perimeter, and volume measurements.

- For concave wounds that have depth, the wound area is the area of an elastic sheet that could be pinned along and stretched across the boundary of the wound. Depth is the distance between the virtual elastic sheet and the wound bed, and volume is the volume enclosed by the sheet.
- For convex wounds and other pathologies (e.g. cellulitis) that rise above the wound outline as drawn in Silhouette, depth and volume have no meaning. In such cases, area is the actual (physical) surface of the wound. One example of a convex surface is the heel.

For further details on the measurement process used by the SilhouetteStar, refer to the "How Silhouette Works" document available from ARANZ Medical support.

### Lighting Requirements for Image Capture

When capturing images with SilhouetteStar, it is important that lighting is at normal office or household lighting levels. SilhouetteStar should not be used in direct sunlight.

Once an image has been captured, you have the option of accepting or discarding the image.

Refer to the Silhouette Administration Manual for further details regarding operating conditions for SilhouetteStar.

### Holding the SilhouetteStar and Positioning the Lasers

To capture images with SilhouetteStar 2, ensure that the camera is connected to Silhouette via a Wi-Fi connection. Then press the capture button so that the camera's lasers and illumination LEDs will be activated.

Hold the camera so that your hand sits comfortably, with your index finger in reach of the button:

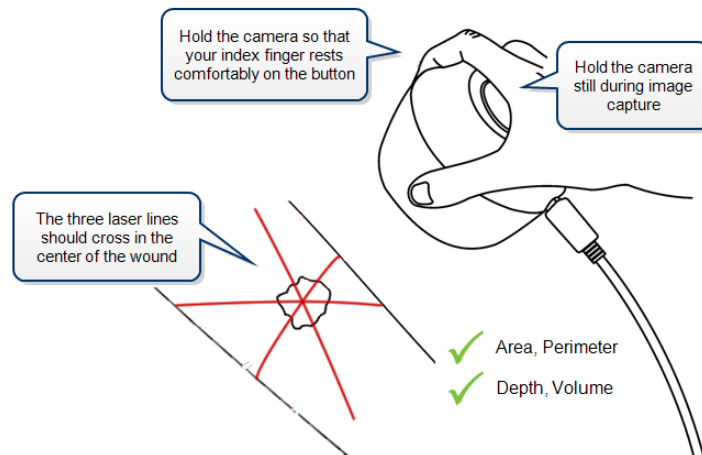

Position the camera facing the wound so that the laser lines cross on or near the center of the wound to form a star shape. The laser lines do not need to cross in a perfect star shape.

For wounds with an uneven wound bed, position the star so that at least one laser line lies across the deepest part of the wound.

The length of the laser line indicates the approximate maximum wound size that can be captured in one image. It is acceptable to move the camera away from the wound, forming a small triangle with the laser lines, in order to capture a large wound in one image. If it is not possible to capture the entire wound in a single image, follow the instructions in [Taking a Multiple Image Measurement](#).

Gently squeeze the button to capture the image, keeping the camera still until you hear the shutter sound from Silhouette or, if your computer's sound is off, until the image appears on-screen in Silhouette. Continue capturing as many images as required.

The set of measurements able to be made on a captured image depends on the positioning of the laser lines and the wound outline. Area and perimeter measures can be made under all circumstances. To determine depth and volume, the following conditions must be met:

- The star-point must be positioned within the wound outline. (The star-point is the point where the three laser lines cross, or if there is a triangle, the point at the center of the triangle.)
- There must be some laser line within the wound outline.
- There must be only a single outline.
- The outline must contain no islands.

This is illustrated in the following examples.

### Preferred Laser Positioning

For a typical wound, it should be possible to place the star-point inside the wound with a laser line through the deepest part of the wound.

## 14 • Acceptable Laser Positioning for Large Wounds

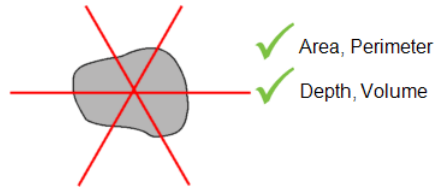

### Acceptable Laser Positioning for Large Wounds

It has been necessary to pull SilhouetteStar away from the wound in order to see the entire wound in the field of view of the camera.

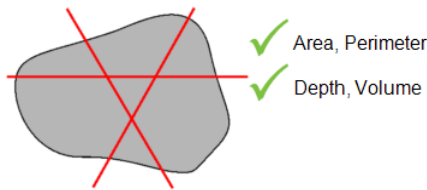

### Preferred Laser Positioning for Wounds Containing Islands

Depth and volume are not calculated when there is an island inside the wound outline.

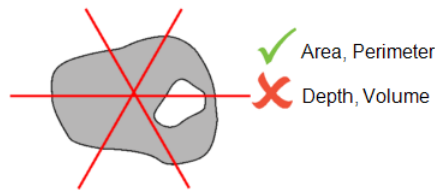

### Preferred Laser Positioning for Wounds With Multiple Outlines

Depth and volume are not calculated when there is more than one wound outline. An alternative strategy that will allow depth and volume to be calculated is to image each wound fragment and outline each wound separately, in the same assessment.

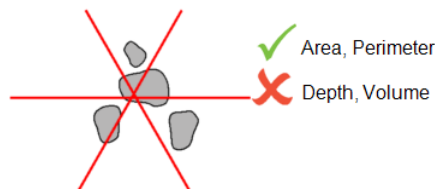

### Poor Laser Positioning

Depth and volume are not calculated if the star-point is not inside the wound outline. In any case, the laser lines have been positioned poorly, and the user should move SilhouetteStar closer to form a star, and center it on a wound.

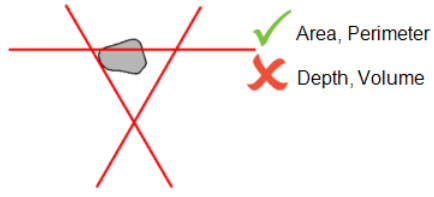

## Taking a Multiple Image Measurement

If it proves difficult to capture a wound in one image, you can capture a series of images and individually outline the separate segments. Silhouette will then automatically calculate wound area for the different segments of the wound. This is useful for large wounds, or a wound that occurs on a part of the body that is curved, or a circumferential wound, which can all be difficult to capture in a single image.

Follow these steps:

1. Plan where the different images of the wound will be captured.
2. Use a surgical marker to mark on healthy skin where the edges of the different images will fall.

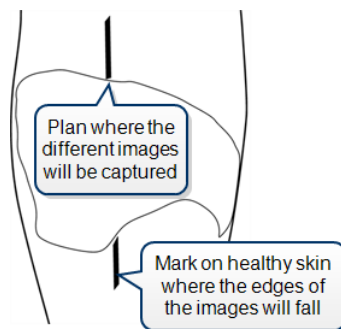

3. Capture an image of each segment of the wound and the surgical marker lines. Make sure the laser crossing point is located within the wound segment.
4. Assign each image to the same wound.
5. For the first image, start at a surgical marker point and trace the wound boundary for the first segment. Stop when you reach the other surgical marker point, then click on the target to close the wound boundary.

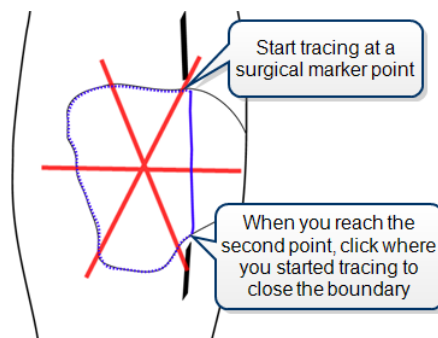

6. For the next image, trace the second segment of the wound in the same manner as the first. Try to draw the outline as close as possible to where you drew the outline for the first segment of the wound.

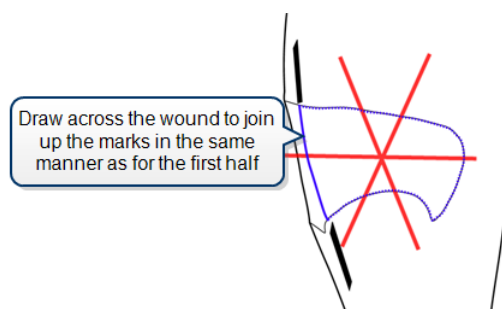

When wound area is calculated, the measurements for the different parts of the wound will be combined to give overall measurements for the wound. Maximum depth and volume will not be calculated.

## The SilhouetteStar Camera

There are two variants of the SilhouetteStar known as:

**SilhouetteStar 1:** This SilhouetteStar has a 3 megapixel camera module and connects to SilhouetteConnect using a USB cable.

**SilhouetteStar 2:** This SilhouetteStar 2 has a 5 megapixel camera module, a display and connects to SilhouetteCentral wirelessly using Wi-Fi or directly to SilhouetteConnect through a USB cable.

## SilhouetteStar Components

### Top View

The SilhouetteStar 2 has a display for showing status information:

(Note: Display only present on SilhouetteStar 2)

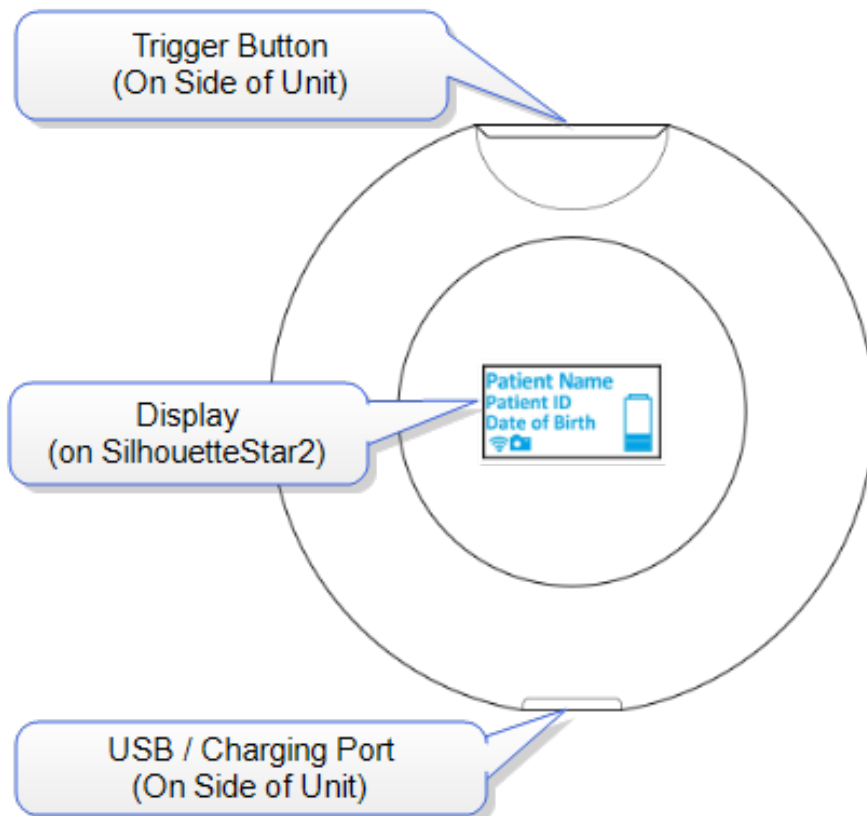

## Bottom View

The location of SilhouetteStar's laser lights, LEDs, and camera lens are shown below:

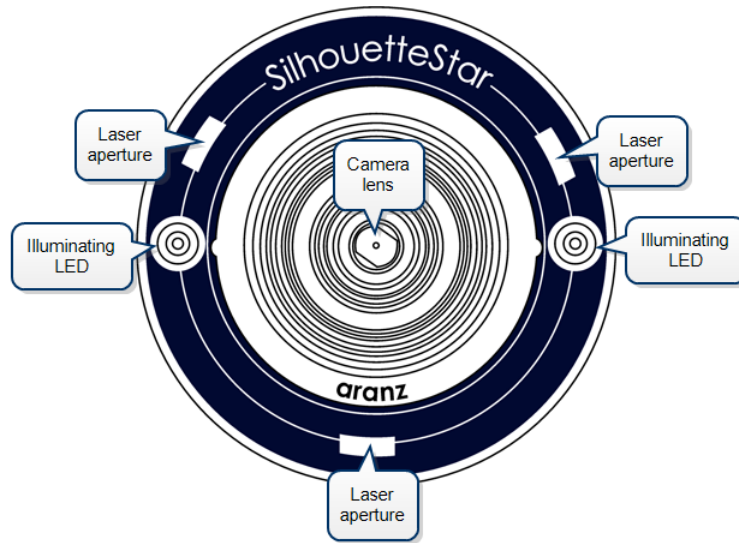

## Side Views

The SilhouetteStar has a single button for powering on and taking images. On the opposite side there is a USB port for charging and connecting the camera to a computer - if being used in a wired configuration.

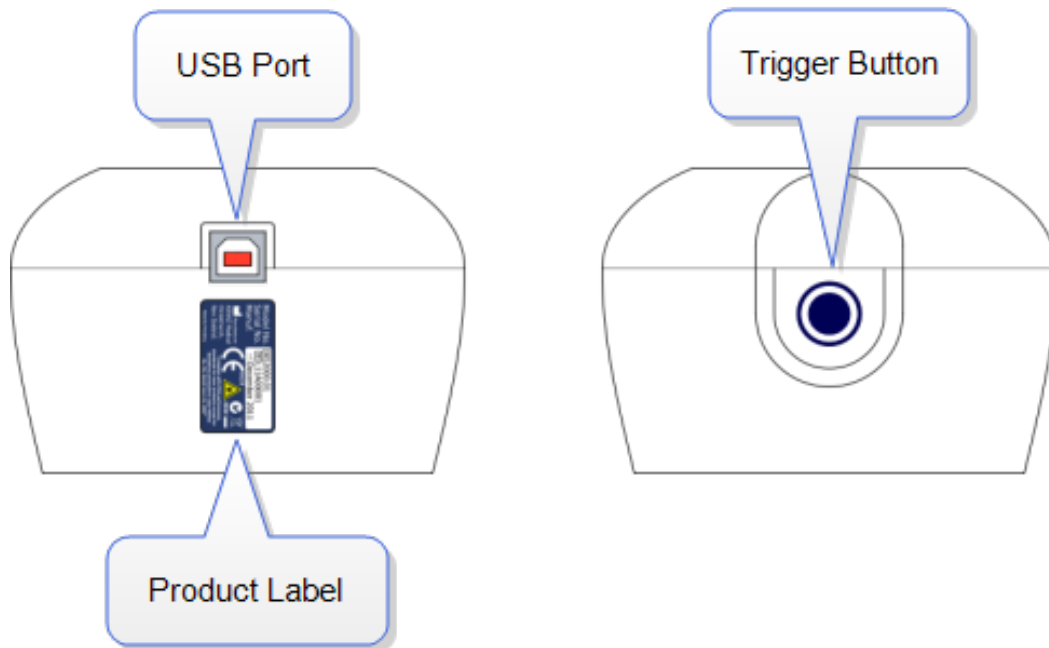



## The SilhouetteStar 2 Display

There are several parts to the display:

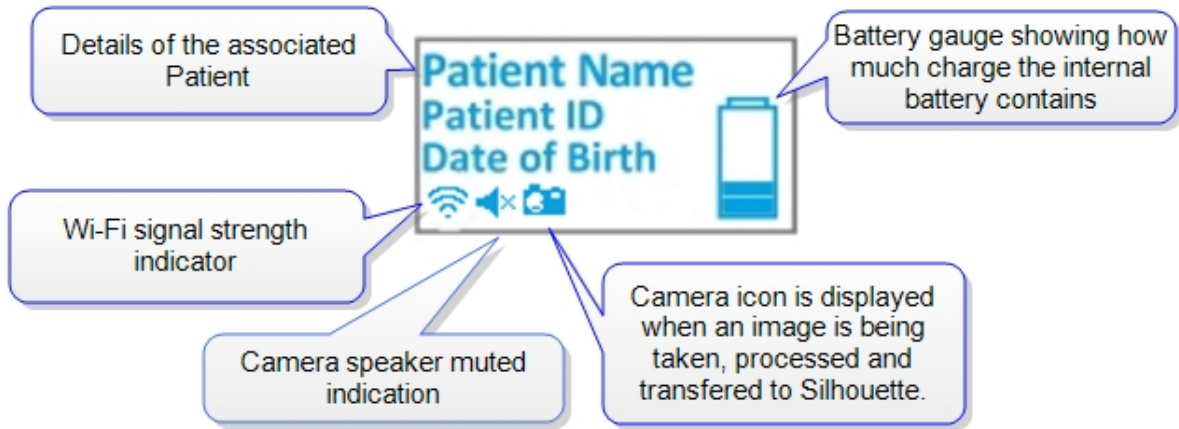

NOTE: The display screen above shows the status when the camera is connected to Silhouette and is ready to take image for a specific patient. Other images shown on the display are listed below.

## Display States

### Display Shows



### Description of Camera State

The Camera is in idle mode / powering up



The Camera is fully powered up and is awaiting the user to scan a QR code which will enable it to connect to the wireless network.



The Camera is attempting to connect to the specified wireless network. If the connection fails ensure you are in range of the correct WiFi. If the connection is still not successful, contact your system administrator.



The Camera is connected and waiting for a patient to be selected in the Silhouette Clinical UI. When connected on Wi-Fi the camera patient selection follows the patient selected in the Web Browser tab that it was initially connected to.



Camera is connected to the network and a patient is selected.



The Camera has gone into sleep mode after being left inactive



An update to the internal operating system is required for the camera to continue to function correctly with SilhouetteCentral. The upgrade will proceed automatically with progress indication.

## SilhouetteStar Button Modes

The button on the side of the SilhouetteStar is used for capturing images (single button press); and in the case of SilhouetteStar 2 is used for powering on the unit, and powering down (by holding the button down for 6 seconds). In general, the usage of the button is a short press to turn the lasers on and then another short press to capture an image. The exact action of the button is dependent on the camera state and what the next action needs to be.

Camera State	Button Action	Result
Camera Off	Short Press	Camera turns on <i>(SilhouetteStar 2 only)</i>
Camera Not Connected	Short Press	Lasers On Ready to scan QR Code <i>(SilhouetteStar 2 only)</i>
Camera Connected	Short Press	Lasers On Ready to take image <i>(SilhouetteStar 2 only)</i>

## 22 • Resetting SilhouetteStar 2

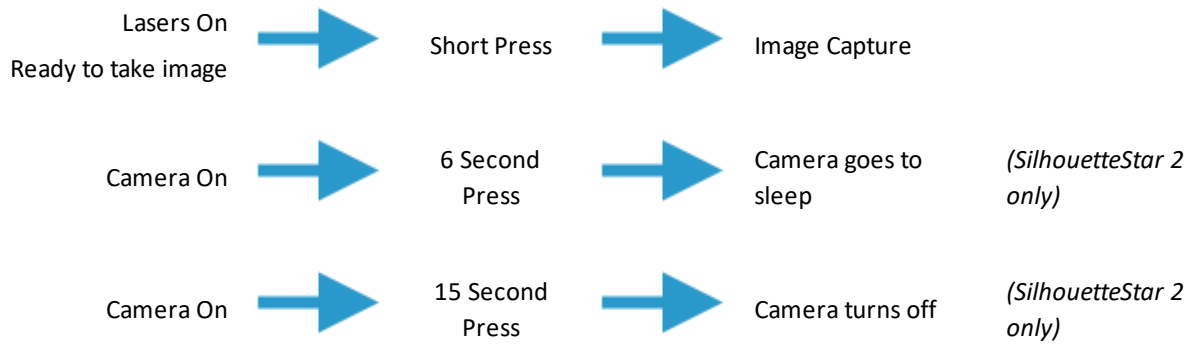

## Resetting SilhouetteStar 2

The Camera can be put to sleep by holding the button down.

5 seconds	Sleep mode (sleeping kiwi)
15 seconds	Deep sleep mode (screen off)
45 seconds	Hard power reset

## SilhouetteStar 2 Battery Management

The SilhouetteStar 2 contains a battery to enable wireless use.

To charge the battery use the supplied battery charger and leave the camera off. The camera will not charge while it is being used.

Ensure that the battery is fully charged before first use - this should take approximately 2 hours. Ensure there is sufficient charge in the battery before attempting image capture to avoid the SilhouetteStar 2 going completely flat.

## Disconnecting the Camera

You may leave the camera connected to Silhouette and it will turn off after a period of inactivity, but if you do wish to disconnect the camera, you can do this at any time.

Either log out from Silhouette, or turn the camera off by holding the capture button down for more than 15 seconds (until the screen goes black (except for the battery charge indicator)).

## SilhouetteStar Label Information

The warning label on the SilhouetteStar camera shows information about your SilhouetteStar. The symbols on the label and their meanings are as follows:



Manufacturers reference / Model number

Model Number	SilhouetteStar Model
2010.01	SilhouetteStar2 (5MP)



Manufacturer assigned device serial number



Date of Manufacture



Manufacturer ARANZ Medical Limited  
Tel +64-3-374-6120, Fax +64-3-374-6130

Postal Address:

ARANZ Medical Limited  
PO Box 3894  
Christchurch 8140  
New Zealand

Delivery Address:

ARANZ Medical Limited  
47 Hereford Street  
Christchurch 8013  
New Zealand



CE-mark. EU Declaration of Conformity and Notified Body Identifier



C-Tick. New Zealand and Australia Declaration of Conformity and Identifier



Warning: Laser light. SilhouetteStar is designated as a Class 1 laser product during all operational procedures.

## 24 • SilhouetteStar Label Information



Waste Electrical and Electronic Equipment Directive (WEEE) Symbol. Separate collection for electrical and electronic equipment under WEEE EC Directive.



Federal Communications Commission logo. The SilhouetteStar2 contains FCC ID: 2ACMW-MX6

This device complies with Part 15 of the FCC Rules. Operation is subject to the following two conditions: (1) this device may not cause harmful interference, and (2) this device must accept any interference received, including interference that may cause undesired operation.

## SilhouetteStar Warnings

References to SilhouetteStar apply to all SilhouetteStar model, except where a specific model is specified.

### Laser Warnings

SilhouetteStar is designated as a Class 1 laser product during all operational procedures. A Class 1 laser product is safe under reasonably foreseeable conditions per the requirements in IEC 60825-1. However, the following precautions are recommended:

- Never stare into the laser beam.
- Do not view the laser with optical instruments.
- Do not use SilhouetteStar in a manner that causes the laser light to shine into people's eyes.
- Warn patients not to stare into the laser beam. Young children or subjects whose natural aversion reflex may be dulled due to medication or a medical condition may be advised to wear a blindfold.
- Operate the device so that it is pointing away from windows, doors, mirrors, and other shiny reflective surfaces, and areas where other people are working.
- There are no controls, adjustments, or user serviceable parts that can affect the laser output. In the event of equipment failure, contact the manufacturer or agent for repair and servicing.

SilhouetteStar complies with FDA performance standards for laser products except for deviations pursuant to Laser Notice No. 50, dated June 24, 2007.



**CAUTION:** Use of controls or adjustments or performance of procedures other than those specified in this guide may result in hazardous radiation exposure.



**WARNING:** Laser light Class 1 product. Do not view directly with optical instruments

### Other Warnings

- Do not use SilhouetteStar in humidity or temperature conditions outside those listed in the Silhouette Administration User Guide.
- Wipe any condensation from the SilhouetteStar protective optical plastic covers.
- Do not touch the optical plastic covering the SilhouetteStar lasers, LEDs or camera lens. Avoid contact with sharp objects. SilhouetteStar should be placed face-down on a clean, dry, flat surface when not in use.
- Use standard sterility protocols. Do not allow SilhouetteStar or the USB cable (if used) to come into contact with the patient or with contaminated materials.
- When using SilhouetteStar in wired configuration, the operator and others in the room should use caution to avoid tripping when the USB cable is draped across the floor. When SilhouetteStar is not in use, the cable should be disconnected and stored.
- Use only a SilhouetteStar USB cable. Use of a non-factory cable may cause interference with other electronic devices and/or unreliable operation.

## 26 • Other Warnings

- If the USB cable becomes damaged, please contact ARANZ Medical for a replacement. Continued use with a damaged cable may cause interference with other electronic devices and/or result in incorrect measurements and/or cause permanent damage to SilhouetteStar or to the attached computer.
- Ensure the computer power supply, and any USB hubs used are approved for medical use according to IEC60601-1.
- Ensure the computer power supply is approved for medical use according to IEC60601-1.
- SilhouetteStar has an Ingress Protection rating of IP40, which means it is protected against dust but not water ingress.
- SilhouetteStar contains no user serviceable parts.
- This product is designed to have a nominal operational life of five years.
- At end of unit life, please recycle in accordance with local government regulations.

### Warnings specific to Model 2010.xx SilhouetteStar (SilhouetteStar 2):

- Use only the charger supplied with the SilhouetteStar 2 for charging its internal battery. Use of any other charger voids the product warranty and could damage the unit.
- The internal Lithium-ion battery pack is rated at 3.8v, 1.7Ah and is charged at 5.00v dc through the USB port on the SilhouetteStar 2 – either via the supplied charger or an approved USB port.
- SilhouetteStar2 contains an internal Lithium-ion battery pack, which is compliant with IEC62133 and UN38.3 standards.

## Care of the SilhouetteStar

The SilhouetteStar is a precision optical instrument and must be handled with care at all times.

- Do not drop, knock, or shake the SilhouetteStar.
- Ensure there is no dirt, moisture, or scratching over the camera, laser and LED apertures.
- Do not let SilhouetteStar come into contact with the patient.
- Keep the SilhouetteStar and the USB cable (if used) clean at all times by regularly wiping them with an antiseptic cloth. Ensure SilhouetteStar and the USB cable are thoroughly dry before use.
- Do not submerge the SilhouetteStar in liquid.
- The SilhouetteStar should be placed face-down on a clean, dry, flat surface when not in use.

## Cleaning the SilhouetteStar

The exterior of SilhouetteStar can be cleaned with a range of common cleaning agents. All cleaning should be performed with the camera disconnected from the host computer. The use of pre-impregnated cleaning wipes is recommended since these will not physically scratch the camera's optical surfaces.

Please note the following:

- Cleaning products should always be used according to the manufacturers' specifications.
- Cleaning agents or techniques not listed in this document should not be used.
- It is your responsibility to ensure product cleaning achieves the desired result.
- Certain cleaning agents may cause discoloration of the housing. Any such discoloration is cosmetic only and will not affect the SilhouetteStar operation and is not covered by warranty.



When cleaning SilhouetteStar, ensure excess fluid from wipes does not enter camera openings.

Compatible cleaning agents are:

- Mild detergent. Do not submerge.
- Water-based wipes
- Alcohol (isopropyl) based wipes
- Hydrogen peroxide-based wipes



Use caution if cleaning with:

- Manual physical cleaning. Avoid abrasive materials. Scratching of the optical covers may negatively impact measurement accuracy.
- Bleach based wipes, low effective concentration (1:50, 1:100).\*
- Bleach based wipes, high effective concentration (1:10). \*



## 28 • Cleaning the SilhouetteStar

\*Use bleach based wipes only where required for decontamination or infection control purposes, not for day to day cleaning. We suggest that the SilhouetteStar be wiped down with these wipes and allowed to thoroughly dry. Do not allow the unit to sit on the wipes, or on a wet bleached surface.



Do not use:

- Ultrasonic cleaning - SilhouetteStar is not designed for liquid submersion.
- Ultraviolet cleaning - SilhouetteStar is not designed for exposure to high levels of ultraviolet light. Damage to the optical components could occur.
- Steam - SilhouetteStar is not designed for contact with steam.
- Thermal disinfection - SilhouetteStar is not designed for thermal disinfection.

## Using SilhouetteLite+

**SilhouetteLite+** is comprised of an application and a range finding sensor for Apple® iPhone®, iPod® touch and iPad® iOS 10+ devices. SilhouetteLite+ enables users to take wound images, obtain non-contact 2D measurements, and record patient notes on their mobile device. The data collected at the patient's bedside is synchronized with SilhouetteCentral over a secure connection when available.

### Topics



[SilhouetteLite+ Wound Imaging Workflow](#)



[The SilhouetteLite+ Sensor](#)



[Setting Up SilhouetteLite+](#)

## SilhouetteLite+ Wound Imaging Workflow

This section provides guidance with the main workflow of SilhouetteLite+, i.e. capture a wound assessment with the SilhouetteLite+ App and Sensor.

1. [Select or Create a Patient in SilhouetteLite+](#)
2. [Select the Assessment Type](#)
3. [Select or Create the Wound to Assess](#)
4. [Performing an Assessment in SilhouetteLite+](#)
5. [SilhouetteLite+ Guidelines for Use](#)

### Select or Create a Patient in SilhouetteLite+

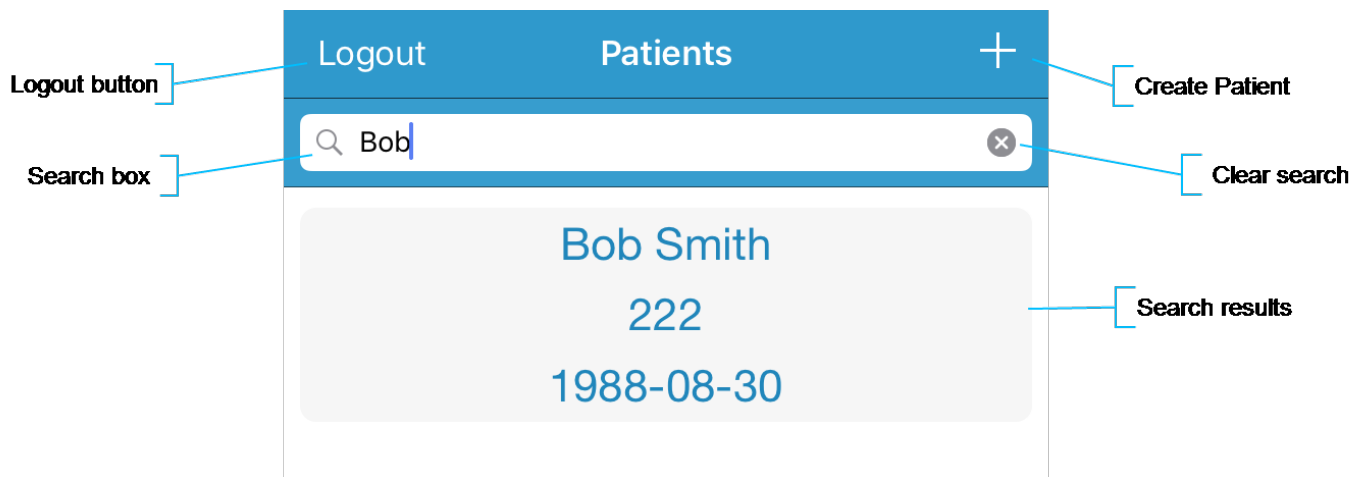

1. Search for the patient by entering part of the patient's name or patient identifier in the search box.



The search matches patients whose names start with the search characters, e.g. searching for "lo" will find a patient called "Lot" but not "Bloggs".

2. Select the patient you want to create an assessment for by touching the patient's name on the screen.



If the patient you are searching for doesn't appear to be in the list then you can attempt to refresh the list by swiping down on the screen.

3. Use the + in the top right of the Navigation bar (top of screen) to create a new patient record.

## Select the Assessment Type

Before performing an assessment you may be asked to select which type of assessment you wish to perform. The exact assessments available to you on this screen will depend on your system configuration. If your system is set such that there is only one assessment type available, then this step will be skipped.

The assessments are split into two overall types, [See "The Organization of Patient Data"](#).

- The first set are patient assessments. These are assessments which relate to the patient as a whole, not just a particular wound.
- The second set are wound assessments. These are assessments which relate to a given wound on a patient. These are typically the assessments where you image and measure individual wounds to track healing.

Select the assessment that you are performing with the patient.

## Select or Create the Wound to Assess

If you are performing a wound type of assessment then you need to select which wound you are performing the assessment on.

This screen presents a list of wounds that are already created for this patient. Wounds are given a letter or number designator which appears at the beginning of the wound label. If the wound designator is a '-' character this means that the wound definition has been created locally and has not been uploaded to SilhouetteCentral yet.

Either select a wound from the list or select the + button in the top right of the screen to create a new wound for the patient. This button is only available if you have the create wound permission.

The create wound button will take you through a set of selection screens allowing you to specify the anatomical site of the wound. There is a chance to enter some additional text at the end of the structured anatomical site selection. The additional text will appear on the wound label.

If you are performing a patient level assessment then the wound selection screen will be skipped.

## Performing an Assessment in SilhouetteLite+

The assessment is split into groups of notes. SilhouetteLite+ presents each group of notes on a separate screen. The bottom of the screen shows the currently selected patient information to allow for positive identification.

## 32 • Using Image Capture Fields

< Back		Next >
Details		
Etiology		
Wound Margins		
Surrounding Skin		
Signs of Critical Colonization or Infection		
Exudate Volume		
Exudate Type		
Bob Smith	222	1988-08-30

- When performing the assessment the **Next** and **Back** buttons on the top of the screen can be used to move between the note groups.
- If a field is required then it has a \* next to the field name.
- The first note group has a **Cancel** button at the top left of the screen. If the **Cancel** button is pressed the current assessment is canceled and all capture notes and images are lost.
- The last note group has a **Save** button at the top right of the screen. Once the **Save** button is pressed the assessment is queued for upload to SilhouetteCentral and is no longer visible within the app.



Once saved, assessments are sent to SilhouetteCentral when the system is online. Data is only uploaded while the app is open, leave the app open until the offline data icon (  ) disappears from the bottom left of the patient selection screen.

### Using Image Capture Fields

Image capture fields show thumbnails of the images captured and show a camera icon allowing you to launch the device camera to capture an image.

1. Select the **camera icon** to launch the camera.

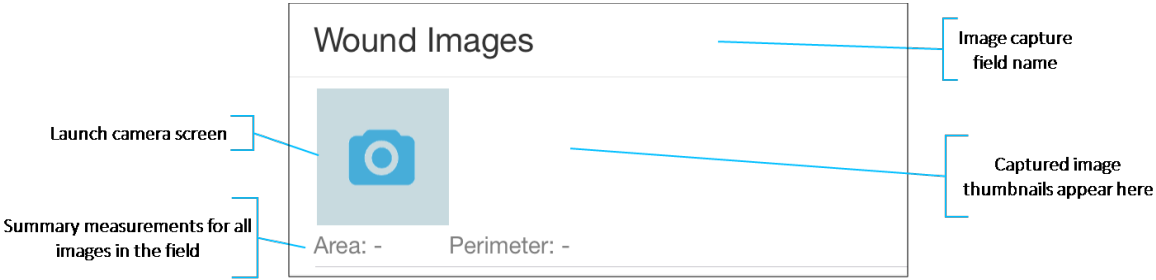

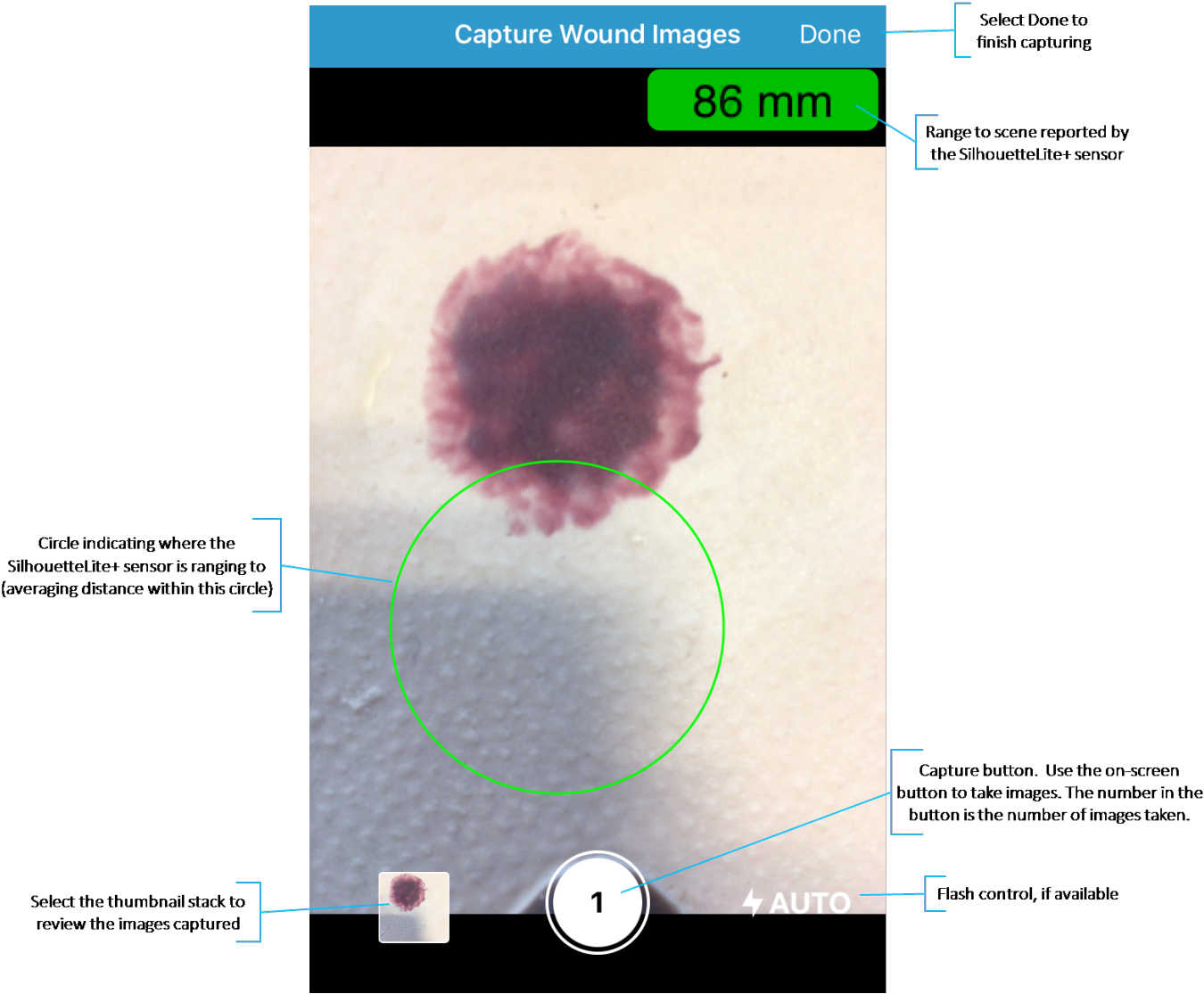

2. The image capture window.

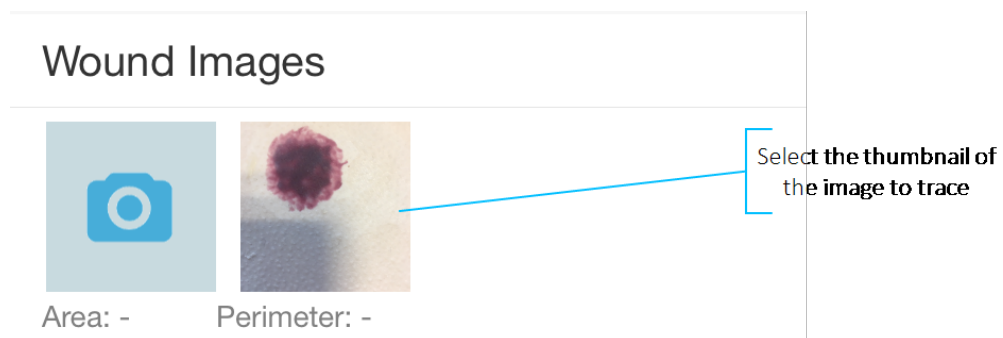

## 34 • Using Image Capture Fields

- The first time the app is used it will ask for permission to access the device camera. Select **Allow**.
- The range to scene measurement reported by the SilhouetteLite+ sensor is in the top right of the screen. Measurements will only be made on an image taken when a valid range is reported. If the sensor is not working or the scene is too close or too far then this will be reported as "Out of Range".
- If the range to scene is being reported by the SilhouetteLite+ sensor then an estimate of where the sensor is reading the range is displayed as a green circle on the screen.
- The range to scene is taken as an average of ranges from within this circle. Make sure the surface you are measuring overflows this circle (i.e. if some of this circle is resting on the bed or chair behind the patient's wound then the range will be wrong and the measurements will have additional error).
- Focus the camera by touching the screen where you would like it to focus.
- Take up to 10 images using the round capture image button on the screen.
- Select the image stack to review the images and touch any to put a red cross on any that should not be kept.
- Select **Done** to finish capturing images.



 [See "SilhouetteLite+ Guidelines for Use"](#) for more details on getting reliable measurements from SilhouetteLite+.

3. Select a thumbnail of an image to review it, trace it or delete it.

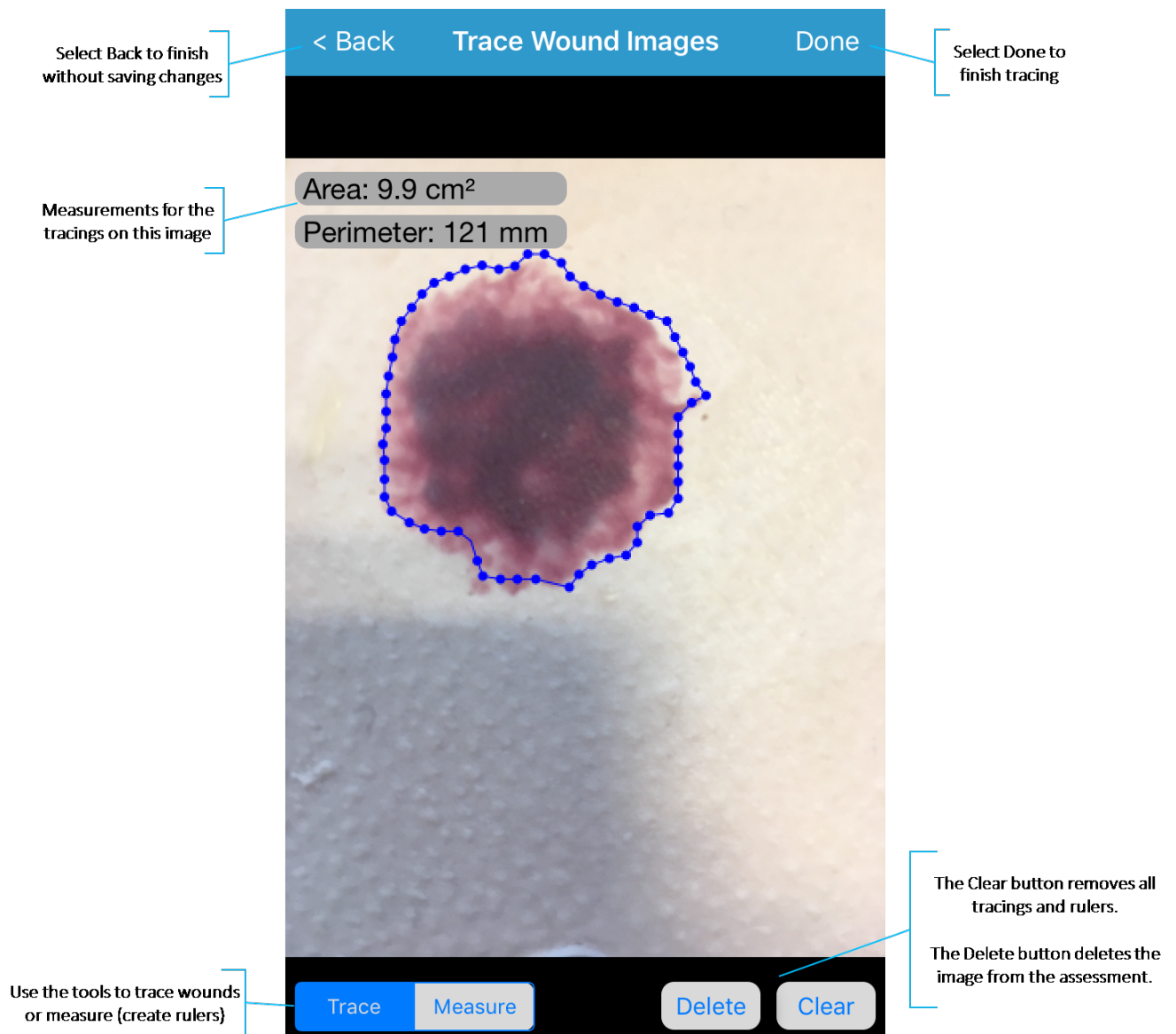

- The **Trace** tool is used to trace wound outlines.
- Trace by dropping points around the wound or by tracing around the wound in one direction until the start of the tracing is reached.
- Only one wound outline is allowed per image. Additional tracings can be added in SilhouetteCentral once the assessment is uploaded.
- SilhouetteCentral calculates the length and width of the traced wound once the assessment is uploaded.
- The **Measure** tool is used to measure between two points.
- The measurement capabilities are only available if there is a valid range measurement from the SilhouetteLite+ sensor along with the image.
- The **Clear** button is used to clear all measurements on the image.



## 36 • Using Notes Fields

- The **Delete** button is used to delete the image from the assessment. A confirmation dialog will confirm.
  - Tracings and rulers added in the SilhouetteLite+ app can be edited using SilhouetteCentral once the assessment is uploaded.
  - Select **Done** to accept changes to the tracings.
  - Select **Back** to close the tracing screen without saving any changes.
4. The image capture field will update the area and perimeter measurements below the thumbnails. If more than one image is traced then the area and perimeter measurements are the sum of all tracings, [See "Taking a Multiple Image Measurement"](#).

## Using Notes Fields

The notes fields are displayed in a single line on the screen until they are selected for data entry.

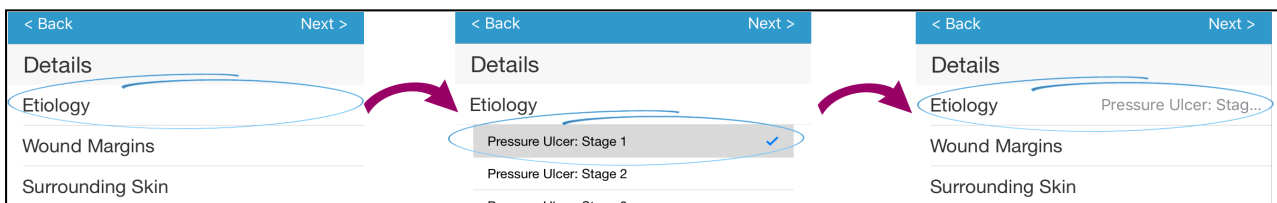

The following points describe the operation of the text entry fields, the selection list fields, boolean (yes/no) fields, date fields, integer fields and the decimal fields:

- Touch the field name to open the data entry for the field.
- Enter data into the field using the device keyboard or by selecting the option(s) required.
  - On some fields it may be necessary to scroll the screen to allow all options to be seen.
  - On date fields it may be necessary to select the year, then the month, then the day.
- Touch the field name again to close the data entry. A summary of the data entered is displayed next to the name of the field.

## SilhouetteLite+ Guidelines for Use

Follow the below guidelines to get the best and most consistent measurements from SilhouetteLite+:

- Use indoors, out of direct sunlight.
- Use on clean, bare skin.
- Hold device parallel to the wound being imaged.
- Ensure the surface being measured overflows outside the target circle, i.e. don't let the target circle fall off the side of the anatomy being imaged.
- Frame the wound in the camera view in a consistent fashion for every capture (i.e. put the patient in a consistent position and take the image so the top of the image is toward the patients head).

- Ensure that the optical window on the sensor is clean and unobstructed.
- Overflow the target circle with the surface being measured, i.e. don't let the target circle fall off the side of the anatomy being imaged.
- Use with an unmodified device with no additional camera lens elements (e.g. don't use with clip-on lenses or transparent sleeves).

## The SilhouetteLite+ Sensor

This section provides information about your SilhouetteLite+ sensor, including the safety information. It is important that this information is read and understood before using the sensor.

1. [SilhouetteLite+ Label Information](#)
2. [SilhouetteLite+ Warnings](#)
3. [Care of the SilhouetteLite+ Sensor](#)

### SilhouetteLite+ Label Information

The marking on the SilhouetteLite+ sensor shows information about your SilhouetteLite+ sensor. The symbols on the label and their meanings are as follows:

**Model**

Model Number	SilhouetteStar Model
2100.01	The original SilhouetteLite+ sensor

**Serial Number**

9-digit code printed on to the bottom bezel of the sensor.

The year and month of manufacture is encoded in the first 3 characters of the serial number.

**Made in New Zealand**

Manufacturer ARANZ Medical Limited  
Tel +64-3-374-6120, Fax +64-3-374-6130

Postal Address:

ARANZ Medical Limited  
PO Box 3894  
Christchurch 8140  
New Zealand

Delivery Address:

ARANZ Medical Limited  
47 Hereford Street  
Christchurch 8013  
New Zealand



CE-mark. EU Declaration of Conformity and Notified Body Identifier



C-Tick. New Zealand and Australia Declaration of Conformity and Identifier



**Warning:** Laser light. SilhouetteLite+ is designated as a Class 1 laser product during all operational procedures.



Waste Electrical and Electronic Equipment Directive (WEEE) Symbol. Separate collection for electrical and electronic equipment under WEEE EC Directive.



Federal Communications Commission logo. The SilhouetteLite+ sensor contains FCC ID: 2AA9B04

This device complies with Part 15 of the FCC Rules. Operation is subject to the following two conditions: (1) this device may not cause harmful interference, and (2) this device must accept any interference received, including interference that may cause undesired operation.

## SilhouetteLite+ Warnings

### Laser Warnings



**WARNING:** Laser light Class 1 product. Do not view directly with optical instruments.

**CAUTION:** Use of controls or adjustments or performance of procedures other than those specified in this guide may result in hazardous radiation exposure.

SilhouetteLite+ sensor is designated as a Class 1 laser product during all operational procedures. A Class 1 laser product is safe under reasonably foreseeable conditions per the requirements in IEC 60825-1. The SilhouetteLite+ sensor laser uses UV light (not visible light). However, the following precautions are recommended:

- Never stare into the laser beam (i.e. the black window on the SilhouetteLite+ sensor) or use SilhouetteLite+ in a manner that causes the laser to shine into people's eye.

The SilhouetteLite+ sensor complies with FDA performance standards for laser products except for deviations pursuant to Laser Notice No. 50, dated June 24, 2007.

### Other Warnings

- The SilhouetteLite+ sensor includes a Bluetooth LE transmitter, which is activated when first placed on the charger. It should be treated as always on. Do not use in an RF Sensitive area.
- Ensure that the mobile device being used with the sensor is approved for use in your medical environment. Clean the SilhouetteLite+ sensor with the same cleaning protocol used to clean the device to which the sensor is attached, i.e. use a slightly damp lint free cloth for cleaning.
- Do not use sensor in humidity or temperature conditions outside those listed in the specifications ([See "SilhouetteLite and SilhouetteLite+ App - Minimum Requirements"](#)).
- Do not touch the optical plastic covering the sensor range finder (i.e. black window in the sensor). Wipe any condensation, dirt, or smudges from the protective optical plastic cover with a lint free cloth.
- Avoid contact with sharp objects.
- Handle the sensor and attached device with care to minimize physical shock.
- The sensor should be placed face-down on a clean and dry surface when not in use.
- The sensor can only be placed onto a device once. If it is removed from a device, the sensor can be damaged and will not be covered under warranty.
- The sensor contains no user serviceable parts.
- This product is designed to have a nominal operational life of two years.

## 40 • Care of the SilhouetteLite+ Sensor

- At end of unit life, please recycle in accordance with local government regulations.
- The sensor contains an internal Lithium-ion battery pack rated at 3.7v, 180mAh and is charged using a wireless (inductive) charger.
- Only use the wireless charger supplied with the sensor for charging the internal battery. Use of any other charger voids the product warranty and could damage the unit.
- Keep the charger at least 20 cm away from implantable medical devices to avoid potential interference with the medical device.
- Do not place the charger too close to cards with magnetic strips or chips (e.g. bank cards) as card failure may occur.

### Care of the SilhouetteLite+ Sensor

The SilhouetteLite+ sensor is a precision optical instrument and must be handled with care at all times.

- Do not drop, knock the SilhouetteLite+ sensor.
- Ensure there is no dirt, moisture, or scratching on the sensor window.
- Do not let the SilhouetteLite+ sensor come into contact with the patient.
- Keep the SilhouetteLite+ sensor clean at all times by regularly wiping it with an antiseptic cloth.
- Do not submerge the SilhouetteLite+ sensor in liquid.

### Cleaning the SilhouetteLite+ sensor

The exterior of the SilhouetteLite+ sensor can be cleaned with a range of common cleaning agents. Cleaning should be performed with the same protocols used to clean the device to which the sensor is attached. The use of pre-impregnated cleaning wipes is recommended since these will not physically scratch the sensor's optical surfaces.

Please note the following:

- Cleaning products should always be used according to the manufacturers' specifications.
- Cleaning agents or techniques not listed in this document should not be used.
- It is your responsibility to ensure product cleaning achieves the desired result.
- Certain cleaning agents may cause discoloration of the housing. Any such discoloration is cosmetic only and will not affect sensor operation and is not covered by warranty.
- It is recommended to use the cleaning protocol used to clean device to which the sensor is attached.

Compatible cleaning agents are:

- Mild detergent. Do not submerge.
- Water-based wipes
- Alcohol (isopropyl) based wipes
- Hydrogen peroxide-based wipes



Use caution if cleaning with:

- Manual physical cleaning. Avoid abrasive materials. Scratching of the optical covers may negatively impact measurement accuracy.

- Bleach based wipes, low effective concentration (1:50, 1:100).\*
- Bleach based wipes, high effective concentration (1:10). \*

\*Use bleach based wipes only where required for decontamination or infection control purposes, not for day to day cleaning.



Do not use:

- Ultrasonic cleaning - the sensor is not designed for liquid submersion.
- Ultraviolet cleaning - the sensor is not designed for exposure to high levels of ultraviolet light. Damage to the optical components could occur.
- Steam - the sensor is not designed for contact with steam.
- Thermal disinfection - the sensor is not designed for thermal disinfection.

## Setting Up SilhouetteLite+

This section provides the details required to perform the initial setup of both the SilhouetteLite+ sensor and the SilhouetteLite+ app.

1. [Download the SilhouetteLite+ App](#)
2. [Unbox the SilhouetteLite+ Sensor](#)
3. [Charging the SilhouetteLite+ Sensor](#)
4. [Attach the SilhouetteLite+ Sensor to Your Device](#)
5. [Setup the SilhouetteLite+ App](#)

### Download the SilhouetteLite+ App

1. Visit the Apple App Store on your device.
2. Search for SilhouetteLite+.



3. Download the SilhouetteLite+ app to install it on your device.

### Unbox the SilhouetteLite+ Sensor

The SilhouetteLite+ Sensor comes in a box with the following items:

- SilhouetteLite+ Sensor
- Quick Start Guide
- Wireless Charging Pad
- USB Cable for the Wireless Changing Pad

The Quick Start Guide contains helpful information to get you started as well as the relevant safety warnings ([See "SilhouetteLite+ Warnings"](#) and [See "SilhouetteLite+ Label Information"](#)). Please review this information before using the device.

Before using the SilhouetteLite+ sensor you will need to place it on the charger.

## Charging the SilhouetteLite+ Sensor

You will need to place the sensor on the charger before the initial use or if the SilhouetteLite+ app reports the sensor not found or reports the sensor as having a low battery.

A full charge from flat typically takes 90 minutes and once charged it is designed to operate for 30 days with normal usage patterns.

The sensor is charged using the supplied Wireless Charging pad. To charge the sensor:

1. Use the supplied USB cable to plug the Wireless Charging Pad into a USB power supply or a USB socket on a computer. A **green** charger LED indicates that the charger has power and is not charging a device.
2. Place the SilhouetteLite+ sensor face down on top of the charger to charge it.
  - The sensor must lie flat on top of the charger for charging to take place.
  - The bottom 2/3 of the sensor should be centered on the charger.
  - A **blue** charger LED indicates that the sensor is correctly placed on the charger and is charging.
  - To charge the sensor once it is attached to a device, place the device and sensor on the charging pad so the sensor surface is lying flat on top of the charger. If you are having difficulty placing the sensor flat on the charger, consider turning everything upside down. i.e. place the device and sensor screen down and put the charger face down on the sensor.
3. The charger LED will turn off once the sensor reaches full charge.
4. Remove the SilhouetteLite+ sensor from the charger to initiate sensor communication and connect your device.



If the sensor is still on the charger and the charger LED is **green**, this indicates that the charge connection has broken and the sensor is no longer being charged. Reposition the charger or the sensor until the LED turns **blue**.



Attaching the SilhouetteLite+ sensor on a device that also supports wireless charging will prevent the device from being charged. If you wish to wireless charge both the device and the SilhouetteLite+ sensor then place the sensor on a removable case.

There is no charge indication on the physical SilhouetteLite+ sensor. The current charge state of the sensor can be seen in the SilhouetteLite+ app. The battery indication in the app will show:

- High - *means the sensor has been recently charged.*
- Medium - *means the sensor has plenty of charge and can be used for days under normal usage conditions.*
- Low - *the sensor has reached low charge. It will still operate for a number of assessments but will eventually stop giving range measurements. The app will continue to report Low sensor battery until the sensor reaches full charge again.*



#### 44 • Attach the SilhouetteLite+ Sensor to Your Device

When the SilhouetteLite+ sensor is on the charger it can not communicate to the SilhouetteLite+ app, and the app will report "Sensor not found" when taking images. Removing the sensor from the charger will enable communications.

#### Attach the SilhouetteLite+ Sensor to Your Device

1. Determine the best position for the sensor on your device. The best position for the sensor is on a flat surface (not overhanging any edges), with the black window on the sensor directly below and as close as practical to the camera lens of your device.
  - Make sure the whole sensor is on a flat surface of the device, not overhanging any edges or sitting on any protruding items.
  - Do not place the sensor over any lenses, microphones, or other sensors on the device.
  - The sensor can be placed directly on your device or onto a hard case or cover, as long as it remains flat. Attaching the sensor to a soft case or cover may cause the sensor to detach as the case is removed.
  - The sensor can not be used under a case or protective sleeve.
2. Ensure the surface of the device is clean.
3. Remove the adhesive backing from the SilhouetteLite+ sensor and attach it to your device.



The sensor can only be attached to a device once. Removing the sensor can damage it, and it will not be covered under warranty.

The figure below shows an example of the sensor placement on an iPad.



## Setup the SilhouetteLite+ App

1. Ensure that the SilhouetteLite+ sensor has been removed from the charger.
2. Enable the Bluetooth functionality on your device.
3. Open the SilhouetteLite+ app on your device.
4. The first time the app is opened it will first ask you to select a sensor. Select the SilhouetteLite+ serial number that matches the serial number on the sensor attached to your device. If you don't have your sensor yet you can **skip** this step and complete it later by accessing the settings menu once logged into the app.
  1. Select the SilhouetteLite+ serial number that matches the number on the sensor attached to your device. If there is more than one sensor in range the closest sensor will typically be listed at the top of the list. If your sensor doesn't appear in the list then charge the sensor for at least 3 minutes, remove it from the charger and try again.
  2. Follow the instructions in the app to enter the information about how the sensor is placed on the device.

- The x and y offsets are entered in mm and are measured from the center of the device camera to the edge of the black window on the sensor. A picture is provided in the app to assist with the measurement. These measurements allow an indication of where the range sensor is working when taking an image.
- A positive value for the x offset means that the left edge of the sensor window is to the left of the device camera. A negative value for the x offset means that the left edge of the sensor window is to the right of the device camera.

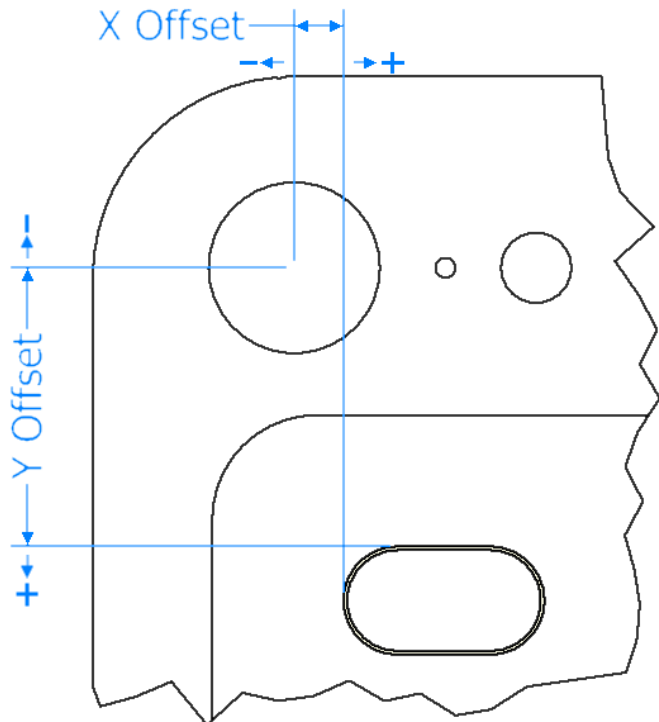

- A positive value for the y offset means that the top edge of the sensor window is below the device camera. A negative value for the y offset means that the top edge of the sensor window is above the device camera.
- If your device has two cameras then take the measurements from the wide angle lens (i.e. the lens closest to the edge of the iPhone 7 Plus).
- Select if the sensor is placed directly on the device or on a case. This selection allows for an adjustment to the range reported by the sensor.

5. After the selection of the sensor then the app will ask for **Your organisation's SilhouetteCentral URL**. Enter the URL of the SilhouetteCentral instance for your organization.

## 46 • Changing SilhouetteLite+ Settings



When entering the SilhouetteCentral URL include the prefix `http://` or `https://`. The URL can be edited at any time by selecting the settings cog in the app.

6. Ensure the device is online and there is a network connection available.
7. Log in to SilhouetteLite+ by entering the **username** and **password** provided to you by your system administrator.



The app will only allow the user to log in when there is an active connection to SilhouetteCentral. Once logged in, the app can be used offline until the user logs out.

### Changing SilhouetteLite+ Settings

Once the settings are configured in the app they can be viewed and changed in the settings menu.

Select the settings cog (  ) on the bottom right of the Patients screen to access the settings menu.

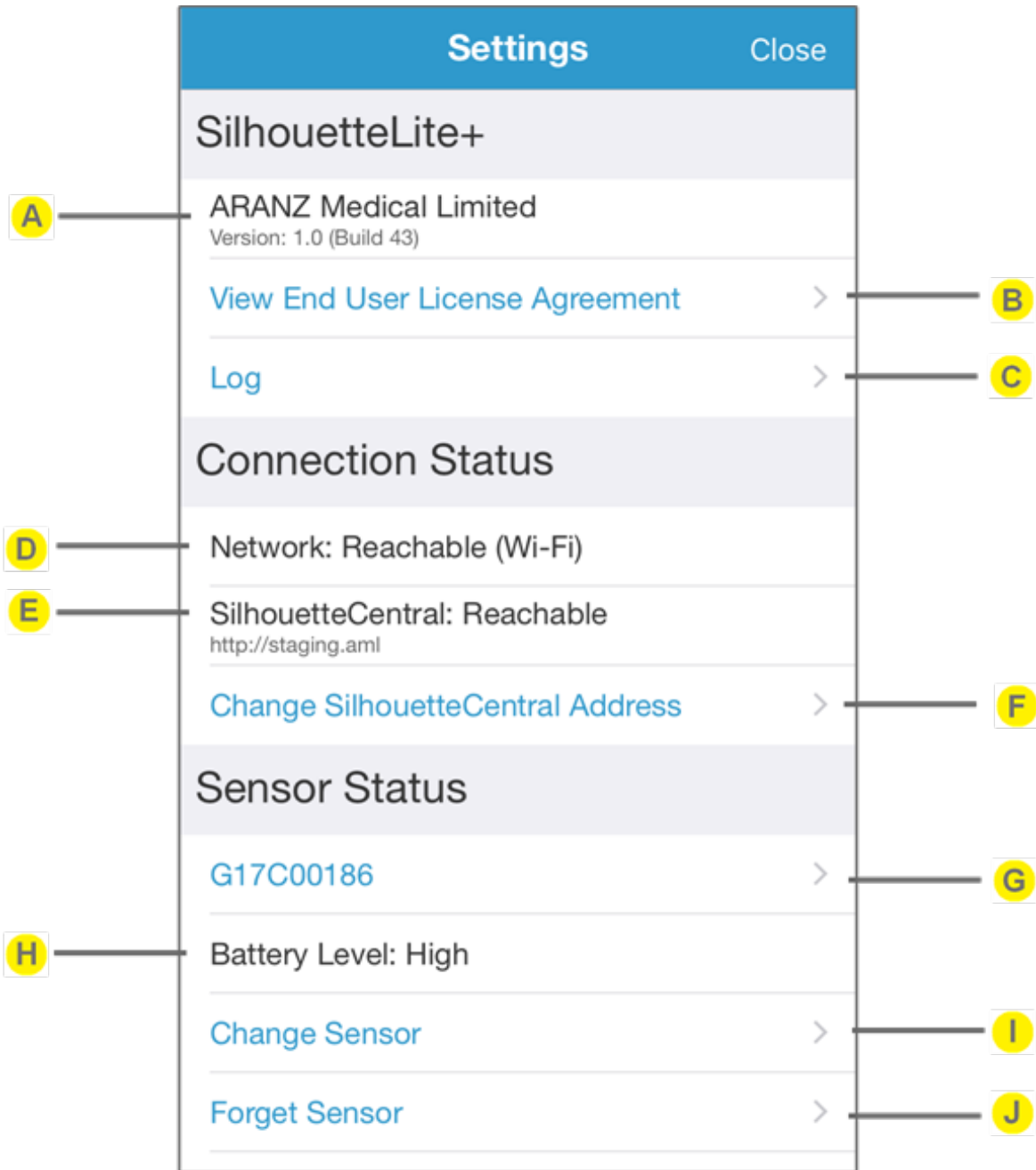

**A** SilhouetteLite+ version and build

**B** Selecting the **View End User License Agreement** opens the Silhouette Suite End User License Agreement in a web browser window. The same content is also contained in this manual, see [CTEULA and Terms of Use](#).

**C** Selecting the **Log** option displays the SilhouetteLite+ log file and provides a button to **Email** the log to your system administrator or to ARANZ Medical support at support@aranzmedical.com.

D

Displays the status of the network connection. **Reachable** means that the app can send data on a network, **Not Reachable** means that the app can't send data on a network. If the network is reported as Not Reachable then check:

- That the device Wi-Fi or mobile data is on and connected.
- If using mobile data then make sure that SilhouetteLite+ is not restricted from mobile data use. This can be found in the Settings app

E

Displays the status of the connection to SilhouetteCentral and the URL that it is trying to reach SilhouetteCentral on. **Reachable** means that the app can send and receive data to and from SilhouetteCentral. **Not Reachable** means that the app can not send or receive data from SilhouetteCentral and the app is operating in offline mode.

If the network is listed as Reachable but SilhouetteCentral is listed as Not Reachable then check:

- The network the device is using (Wi-Fi or mobile data) is able to connect to SilhouetteCentral. Some public networks might not be able to reach SilhouetteCentral servers which are behind corporate firewalls.
- The URL listed is the correct URL for your organization's SilhouetteCentral. It will uncommon to have this correct.
- SilhouetteCentral may be down for maintenance, check with your system administrator.
- One way to confirm if the SilhouetteCentral can be reached on your network is to put the listed SilhouetteCentral URL into your devices web browser.

F

The **Change SilhouetteCentral Address** option allows you to change the SilhouetteCentral URL. This should only be changed if requested by your system administrator. Changing it will delete any offline data and log you out of the app.

G

The serial number of the connected SilhouetteLite+ sensor is listed. If the serial number is blue then you can select the serial number to open the SilhouetteLite+ sensor information screen, which shows:

- Sensor model number
- Sensor serial number
- Sensor Battery Level
- Current range reported by the sensor with a status value. The range is reported without the Z offset adjustment and the a status of 0 means good. A status of any other value means that the sensor is operating outside the design values (e.g. the object is too far or too close for the range sensor).
- Firmware revision of the sensor
- Hardware revision of the sensor
- Software revision of the sensor
- The X, Y and Z offsets set in the app for the sensor are also listed. To change these select **Change Sensor** from the app Settings menu

If the app can not currently communicate to the sensor (e.g. the sensor is flat or on charge) then the sensor serial number will shown in gray and the sensor information screen can not be accessed.

If there is no sensor currently configured in the app (e.g. the sensor selection was skipped on app startup or the Forget Sensor option has been used) then **No Sensor Selected** is displayed instead of a serial number and an option **Select Sensor** is available to go through the sensor selection process. [See "Setup the SilhouetteLite+ App"](#).

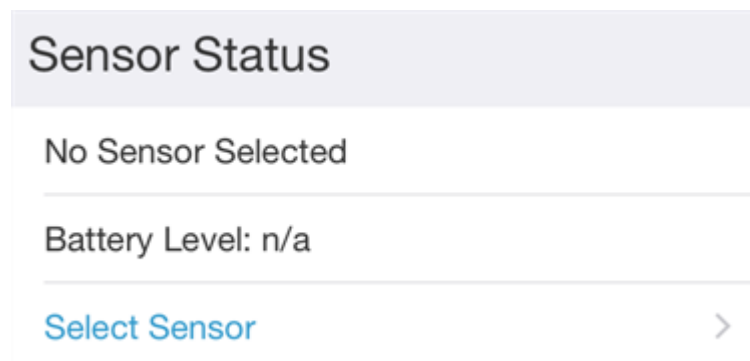

**H**

Indicates the battery level of the sensor or **n/a** if a sensor cannot be found.

The battery level is shown as High, Medium or Low (requires charge). The sensor will still be able to perform a number of assessments with a Low battery but the sensor should be placed on charge at the earliest convenience.

Once the sensor is reporting a Low battery level it will continue to report a low battery level until it receives a full charge.

[See "Charging the SilhouetteLite+ Sensor"](#) for information on charging the sensor.

**I**

Use the **Change Sensor** option to select a new sensor or to change the X, Y, or Z offset values being used. [See "Setup the SilhouetteLite+ App"](#) for details.

**J**

Use the **Forget Sensor** option to remove the association between the mobile device and the sensor.

This option can be useful if one sensor is shared between a number of devices (i.e. attached to a removable case). When one device has the sensor selected and the app open then the sensor will not communicate to a second device.

There is also a settings cog () on log in screen which allows access to only the **Change SilhouetteCentral Address** option.

## Using SilhouetteLite

**SilhouetteLite** is an application designed for Apple® iPhone®, iPod® touch and iPad® iOS 10+ devices. SilhouetteLite is a simplified application that enables users to add patients, wound images and simple notes (without measurements) to SilhouetteCentral. The data collected at the patient's bedside is synchronized with SilhouetteCentral over a secure network connection when available.

This section of the guide goes through the main workflow to capture a wound assessment with the SilhouetteLite App.

1. [Download the SilhouetteLite App](#)
2. [Setup SilhouetteLite](#)
3. [Select or Create a Patient in SilhouetteLite](#)
4. [Perform an Assessment in SilhouetteLite](#)
5. [Changing SilhouetteLite Settings](#)

### Download the SilhouetteLite App

1. Visit the Apple App Store on your device.
2. Search for SilhouetteLite.



3. Download the SilhouetteLite app to install it on your device.

### Setup SilhouetteLite

1. Open the SilhouetteLite App.



2. The first time the app is opened it will ask for **Your organisation's SilhouetteCentral URL**. Enter the URL of the SilhouetteCentral instance for your organization.

 When entering the SilhouetteCentral URL include the prefix `http://` or `https://`. The URL can be edited at any time by selecting the settings cog in the app.

3. Ensure the device is online and there is a network connection available.
4. Log in to SilhouetteLite by entering the **username** and **password** provided to you by your system administrator.

 The app will only allow the user to log in when there is an active connection to SilhouetteCentral. Once logged in, the app can be used offline until the user logs out.

## Select or Create a Patient in SilhouetteLite

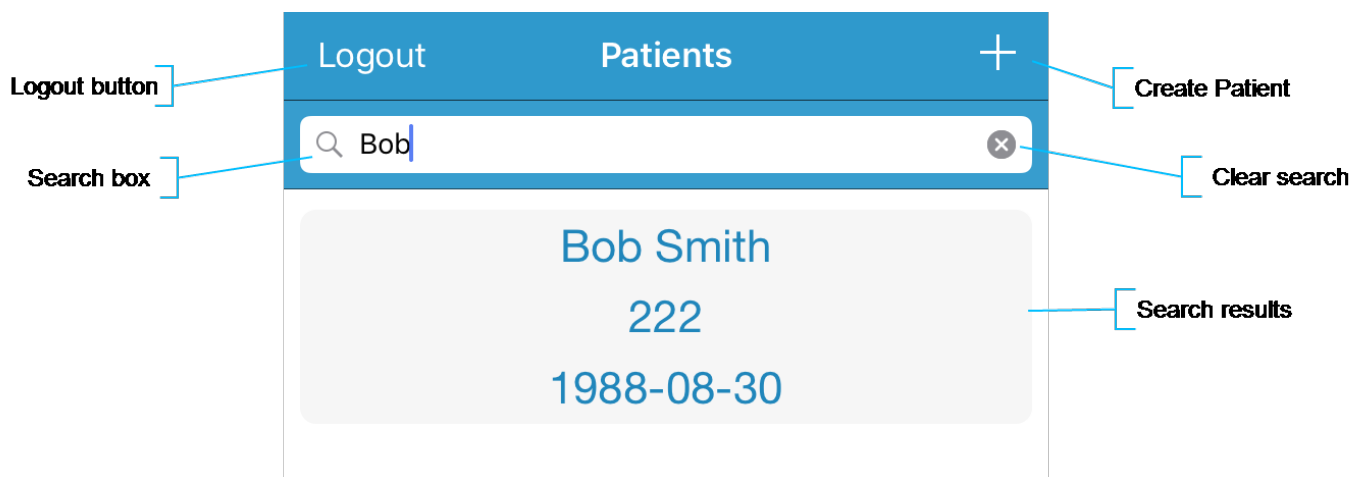

1. Search for the patient by entering part of the patient's name or patient identifier in the **searchbox**.

 The search matches patients whose names start with the search characters, e.g. searching for "lo" will find a patient called "Lot" but not "Bloggs".

2. Select the patient you want to create an assessment for by touching the patient's name on the screen.

 If the patient you are searching for doesn't appear to be in the list then you can attempt to refresh the list by swiping down on the screen.





## 52 • Perform an Assessment in SilhouetteLite

3. Use the + in the top right of the Navigation bar (top of screen) to create a new patient record.

### Perform an Assessment in SilhouetteLite

Once a patient is selected then the device camera opens to allow you to capture wound images.

1. Focus the camera by touching the screen where you would like it to focus.
2. Take up to 10 images using the round capture image button.
3. Select the image stack to review the images and unselect any that should not be kept.
4. Once complete, select **Done** to finish capturing images.
5. Select the note title to enter text into the notes.
6. Select **Save** to complete the assessment.

 Once saved, assessments are sent to SilhouetteCentral when the system is online. Data is only uploaded while the app is open, leave the app open until the offline data icon (  ) disappears from the bottom left of the patient selection screen.

### Changing SilhouetteLite Settings

Once the settings are configured in the app they can be viewed and changed in the settings menu.

Select the settings cog (  ) on the bottom right of the Patients screen to access the settings menu.

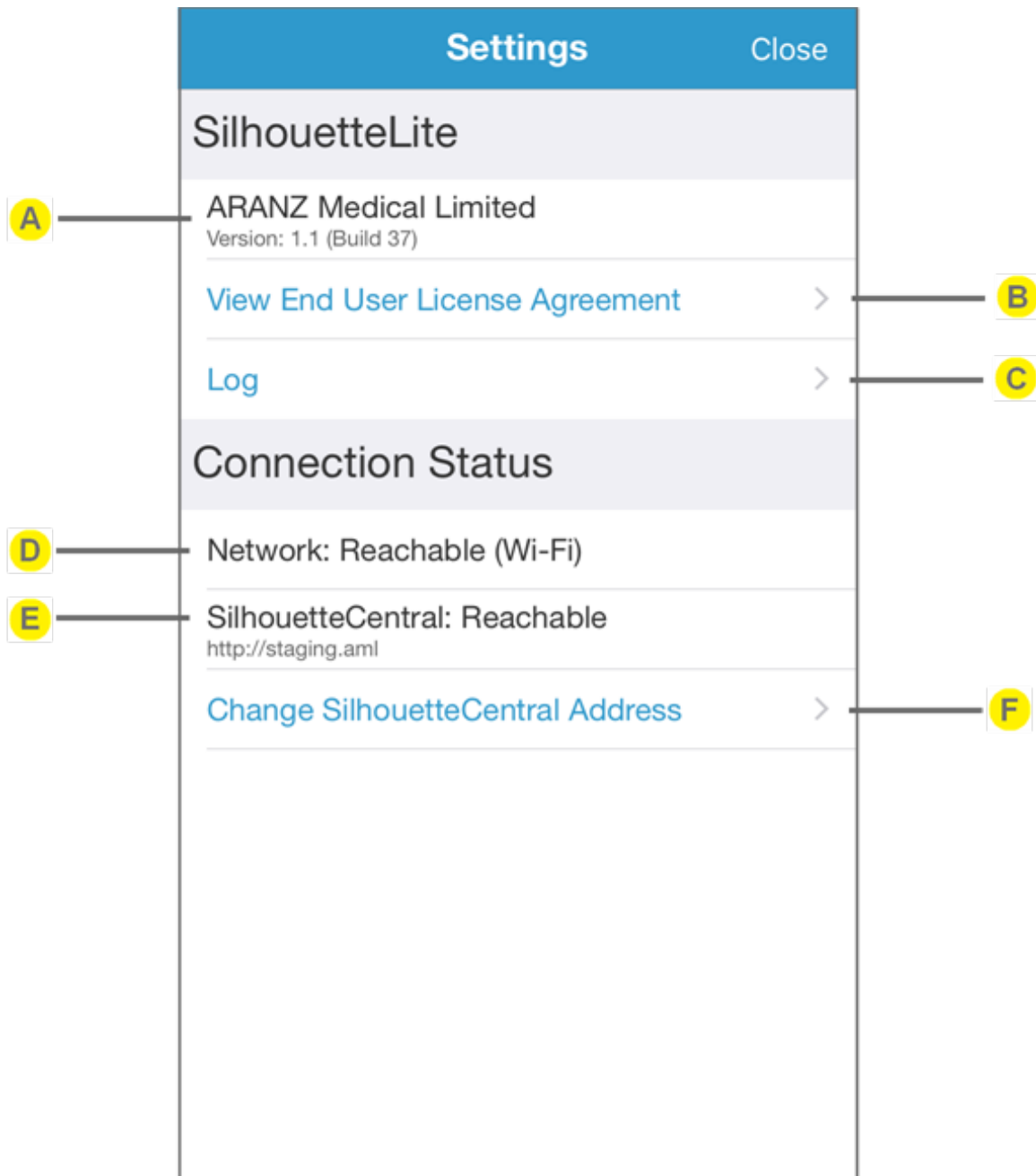

**A** SilhouetteLite version and build

**B** Selecting the **View End User License Agreement** opens the Silhouette Suite End User License Agreement in a web browser window. The same content is also contained in this manual, see [CTEULA and Terms of Use](#).

**C** Selecting the **Log** option displays the SilhouetteLite+ log file and provides a button to **Email** the log to your system administrator or to ARANZ Medical support at [support@aranzmedical.com](mailto:support@aranzmedical.com).

D

Displays the status of the network connection. **Reachable** means that the app can send data on a network, **Not Reachable** means that the app can't send data on a network. If the network is reported as Not Reachable then check:

- That the device Wi-Fi or mobile data is on and connected.
- If using mobile data then make sure that SilhouetteLite is not restricted from mobile data use. This can be found in the Settings app

E

Displays the status of the connection to SilhouetteCentral and the URL that it is trying to reach SilhouetteCentral on. **Reachable** means that the app can send and receive data to and from SilhouetteCentral. **Not Reachable** means that the app can not send or receive data from SilhouetteCentral and the app is operating in offline mode.

If the network is listed as Reachable but SilhouetteCentral is listed as Not Reachable then check:

- The network the device is using (Wi-Fi or mobile data) is able to connect to SilhouetteCentral. Some public networks might not be able to reach SilhouetteCentral servers which are behind corporate firewalls.
- The URL listed is the correct URL for your organization's SilhouetteCentral. It will uncommon to have this correct.
- SilhouetteCentral may be down for maintenance, check with your system administrator.
- One way to confirm if the SilhouetteCentral can be reached on your network is to put the listed SilhouetteCentral URL into your devices web browser.

F

This option allows you to change the SilhouetteCentral URL. This should only be changed if requested by your system administrator. Changing it will delete any offline data and log you out of the app.

There is also a settings cog (  ) on log in screen which allows access to only the **Change SilhouetteCentral Address** option.

## The Silhouette Clinical UI

**SilhouetteCentral** is a computerized wound imaging, analysis, and documentation system. SilhouetteCentral enables users to review, report, securely share and analyze the wound data collected by SilhouetteStar 2, SilhouetteLite+ and SilhouetteLite applications. SilhouetteCentral is accessed via a web-based application.

SilhouetteCentral is divided into two parts:

- Clinical UI - Provides access to the patient medical data stored in the Silhouette database for reviewing, editing, and updating. Reports, images, and wound measurement data can also be exported for further processing and importing into other applications.
- Administration - Provides facilities to manage units, groups, patients, and system users. SilhouetteCentral can also be used to configure and customize the Silhouette system.

### Topics



[Parts of the User Interface](#)



[The Patient Selection Screen](#)



[The Patient Dashboard](#)



[Assessments](#)



[Wounds](#)



[Tracing Wound Outlines](#)

## Parts of the User Interface

### Navigation

In most SilhouetteCentral screens, you will be presented with three menu groups:

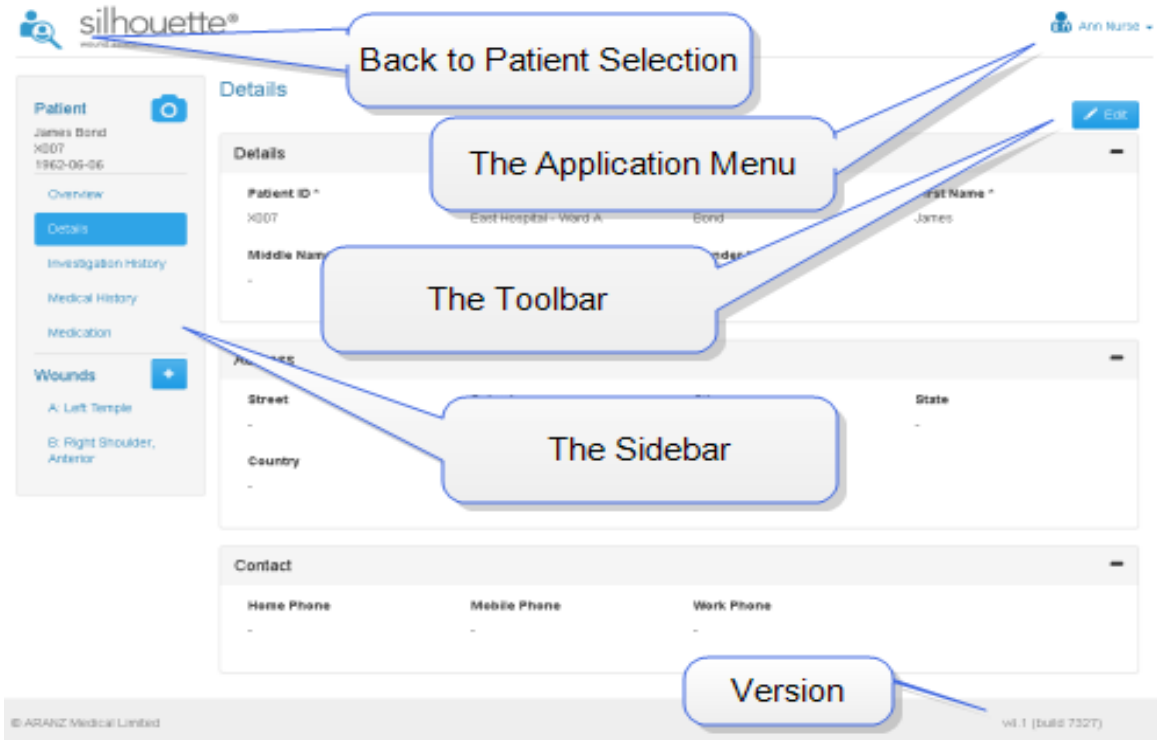

### The Application Menu

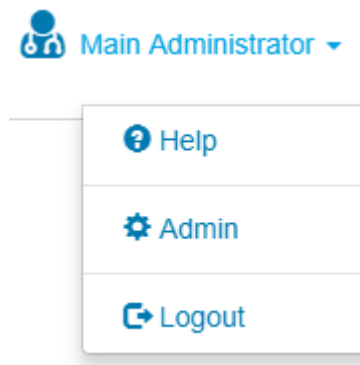

Options that can be found in this menu include:

- **Help** - The User Guides, License Agreement and Legal Notices are found here.
- **Admin** - The options under this menu are permission dependent. Clinical users will find their own user information and password change functionality under this menu, [See "The SilhouetteCentral Admin UI"](#).
- **Logout** - Exit the Program.

## The Toolbar

Options such as Edit, Save, Cancel, Import, Export, Delete, Close can be found here.

The options displayed are dependent on the page you are viewing and the permissions assigned to you by your System Administrator.

## The Sidebar

The Sidebar contains a summary of the selected patient, with the ability to select / create features.

On small screens the sidebar might be off screen to the side and will be brought on screen by swiping or dragging it into view.

## Version

Note that the version of Silhouette is displayed at the bottom-right corner of every page.

## Return to Patient List (Home)

Selecting the Silhouette logo or the Patient search icon at the top-left corner of the screen will at any stage return you to [The Patient Selection Screen](#).

## Selecting Items

Selected items in a list are colored with a blue highlight.

Selected items such as wound labels and images are indicated by a blue outline (below the **Patient > Details** are selected):

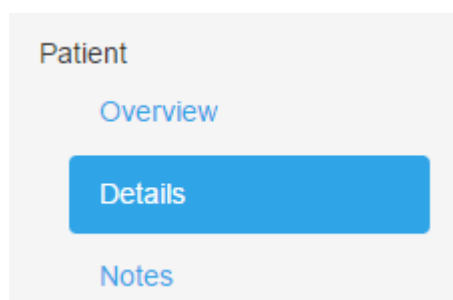

## Workflow

A typical workflow comprises:

1. [Logging In to SilhouetteCentral](#)
2. [Select a Patient](#)

## 58 • Workflow

3. [Connecting the SilhouetteStar 2 using Wi-Fi](#)
4. [Take Wound Images](#)
5. [Create an Assessment](#)

See "[SilhouetteStar Wound Imaging Workflow](#)" for more detailed workflow steps.

## The Patient Selection Screen

After you log on, the list of patients in the database is displayed. Select a patient to create new wounds or assessments for that patient.

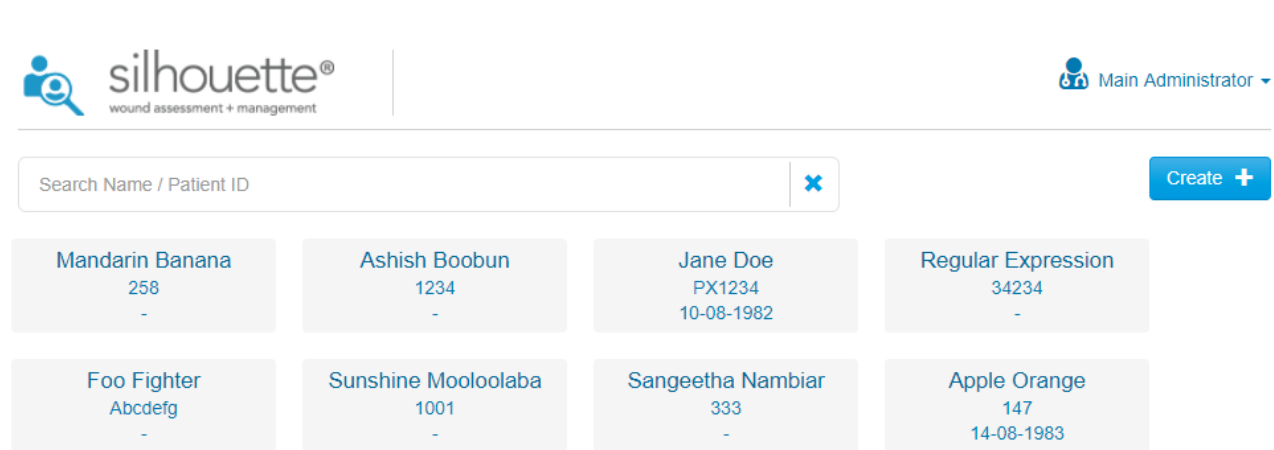

You can:

- Filter the list of patients. Enter part of a patient's name or Patient ID in the **Search** box.
- Start capturing images for a patient. Select that patient, then select the **Portfolio** button to connect the SilhouetteStar 2 camera.
- Add a patient to the database. Select the **Create** button. See [Creating a New Patient](#) for more information.
- Edit the details for an existing patient on Silhouette. Select the Patient, and then go to the **Details** section.

Get back to the patient selection screen at any time by selecting the patient with the magnifying glass icon in the top left of the interface.



## Creating a New Patient

To create a new patient, select the **Create** button in the **Patient Selection** screen. In the screen that appears, fill out the required fields, which are indicated by an asterisk (\*).

To save the information select **Save**, or **Cancel** to return without saving.

## The Patient Dashboard

The patient dashboard shows a summary of information about a selected patient:

The screenshot displays the Patient Dashboard interface. At the top left is the 'silhouette' logo with the tagline 'wound assessment + management'. At the top right, the user is identified as 'Main Administrator'. The dashboard is divided into several sections:

- Sidebar (Left):** Contains patient information: 'Patient', 'Apple Orange', '147', '14-08-1983'. It has a notification badge with the number '9'. Navigation options include 'Overview' (highlighted), 'Details', 'Investigation History', 'Medical History', and 'Medication'. A 'Wounds' section with a '+' icon lists: 'A: Sternum, Inferior', 'B: Forehead, Right Lateral', and 'C: Forehead, Left Lateral'.
- Patient Summary (Top Middle):** Three summary cards: '3 Wounds', '2 Assessments', and '34 Years old'.
- Wounds (Top Right):** A human silhouette with three points labeled 'A', 'B', and 'C'. 'A' is on the chest, 'B' is on the forehead, and 'C' is on the left forehead. 'Right' and 'Left' labels are positioned above the head area.
- Patient Timeline (Bottom):** A vertical timeline with a '+' icon. A recent entry is titled 'Wound B - Wound Assessment' with a timestamp '30-10-2017 16:43:59'. Below the title are two 'Wound Images' showing a close-up of a forehead wound with red laser lines for measurement.

### Patient Summary

A high level overview of the patient is displayed with wound count, assessment count, and patient age.

### Sidebar

The Sidebar provides information on the patient:

- Overview - general patient details.
- Patient Notes - a list of the different patient notes that have been added to the patient, including patient demographic details.
- Wound List - a list of wounds with their label and location.

## 62 • Patient Timeline

These items listed above can be selected to view in greater detail, or to edit if required.

On small screens the sidebar may be hidden off screen. Drag it on and off screen from the left as needed.

### Patient Timeline

The **Patient Timeline** shows all the assessments recorded for the patient, in order of occurrence (newest assessment at top):

#### Patient Timeline

The screenshot displays a vertical timeline on the left with a blue plus icon at the top and three blue circular markers. To the right of the timeline are three assessment blocks:

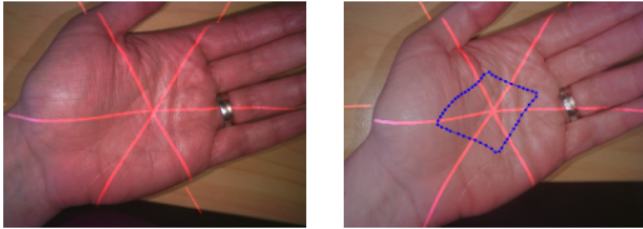
- Visit Assessment**  
🕒 30-10-2017 17:07:09
- Wound B - Wound Assessment**  
🕒 30-10-2017 16:43:59  
**Wound Images**  
  
**Area:** 1486mm<sup>2</sup>      **Island Area:** -      **Perimeter:** 159mm      **Length:** 64mm  
**Width:** 40mm      **Max Depth:** 5mm      **Mean Depth:** 1mm      **Ruler:** -
- Wound A - Wound Assessment**  
🕒 26-10-2017 15:34:40  
**Wound Images**

Each Assessment in the timeline has a title, the date and time of the assessment, a thumbnail (if an image has been captured) and summary information about the wound (if applicable).

To view the Assessment in greater detail, click on the assessment block in the timeline.

To view the image in full screen / edit the [Wound Images](#), click on assessment block to open the assessment, and then select the image.

The Patient Timeline is similar to the Wound Timeline, except that it shows all the assessments for the patient. The Wound Timeline only shows patient level assessments and the wound assessments specific to that wound.

## Assessments

Several different types of assessment can be created for a patient, depending on the configuration of the system, but are generally arranged into two common assessment types:

- **Patient Assessment** for assessments about the patient as a whole person.
- **Wound Assessment** for assessments specific to a single wound. Wound assessments are where wound healing is tracked.

Selecting an assessment in the timeline will show that assessment in greater detail:

### Wound Assessment for Wound B on Forehead, Right Lateral: 31-10-2017 11:12:53

Share Edit

Images

Wound Images \*

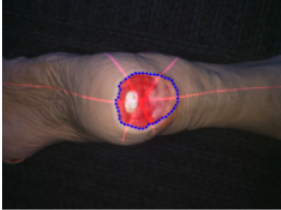

Area: 11.8cm<sup>2</sup>  
Max Depth: 1mm

Perimeter: 12.7cm  
Mean Depth: 0mm

Length: 4.5cm  
Ruler: 4.1cm

Width: 3.7cm

Details

<b>Etiology</b>	<b>Wound Margins</b>
-	-
<b>Surrounding Skin</b>	<b>Signs of Critical Colonization or Infection</b>
-	-
<b>Exudate Volume (vol)</b>	<b>Exudate Type</b>
-	-

The information contained within the assessment can be customized by a system administrator, but generally contains information such as:

- Images
- Wound statistics - such as area, depth, volume.
- Wound history
- Wound details, and the details of the surrounding area.
- Treatment

## New Patient Level Assessment

To create a new **Patient Level Assessment**, select the  button in the **Patient Timeline**, the following information regarding the patient can be stored here:

Admission and discharge information, Physician details, Patients vital signs, General pain levels, etc.

**Note:** The only type of assessment that can be created from the patient dashboard is a patient level assessment.

## Share Button

The **Share** button lets you create reports.

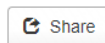

To create a report, select the relevant assessment and select the **Share** button. In the resulting dialog, select the **Generate PDF Report** button:

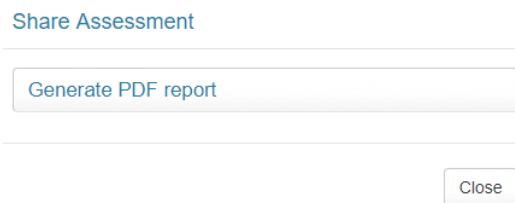

This will cause the report to be generated and downloaded.

## Wounds

The image of the patient shows where on the body the wounds occur, the image below has the wounds labeled A-D.

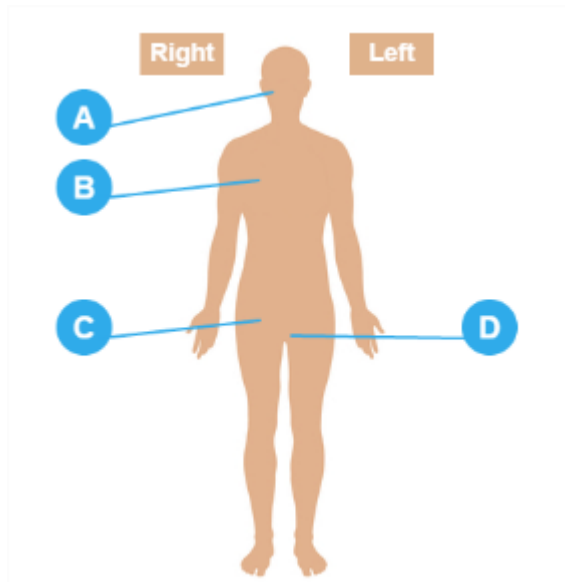

Selecting on the wound label will open the wound summary, this can also be accessed by selecting the wound label on the sidebar.

Create a new wound by selecting the  icon in the side bar beside the wounds heading.

To edit wound details select the wound and use the **Edit Wound** button in the toolbar.

## Wound Dashboard

Selecting one of the **Wounds** from the Sidebar will open the **Wound Dashboard** for that selected Wound:

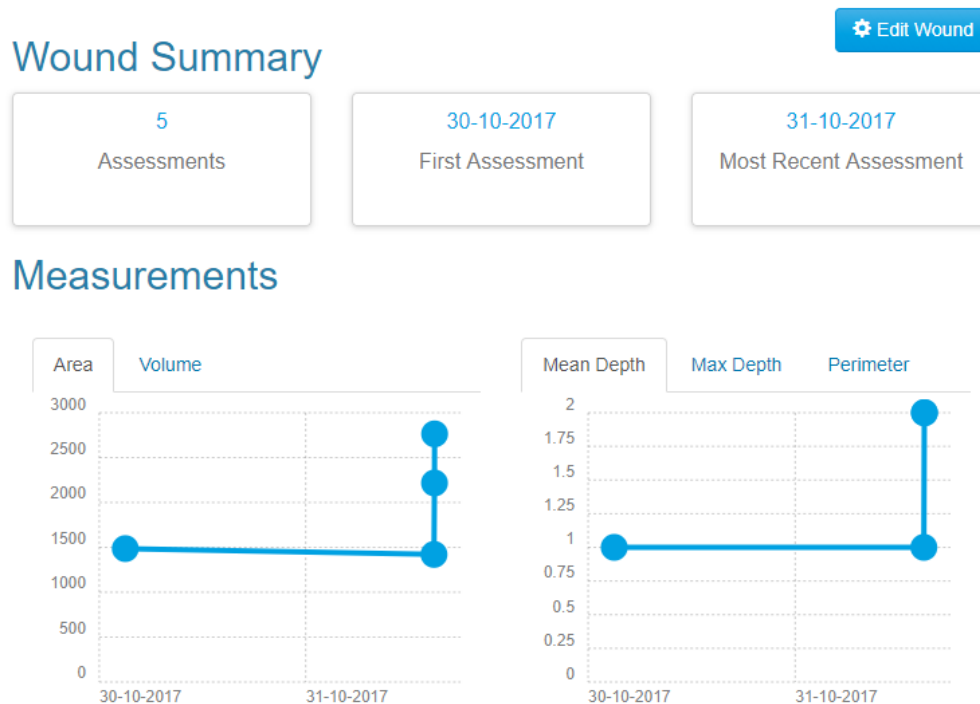

## Wound Timeline

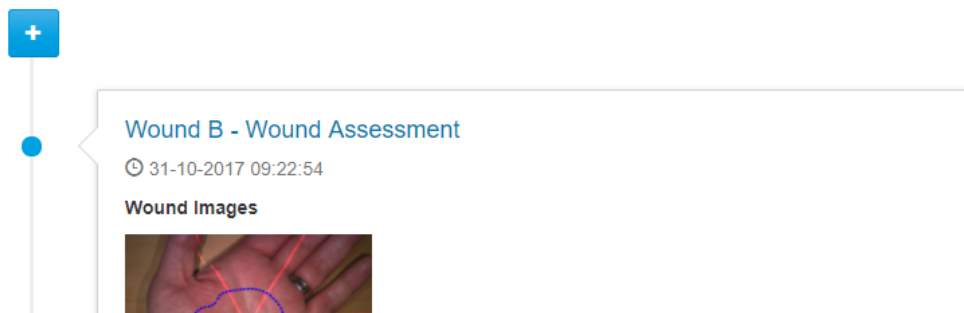

This key features of this screen are:

- **Wound Summary** - showing the duration of the wound, how many assessments have been made, the status of the wound and treatment plan
- **Measurements** - graph showing how the wound has changed over time (select the required view by using on the tabs across the top of the graph).
- **Wound Timeline** - The assessments made on the wound are displayed in chronological order, with thumbnails and summary details.

## Measurements

Measurement graphs are displayed on the **Wound Dashboard** to chart the progress of the selected wound. Tabs across the top show for measurement graphs depending on the data present - such as Area, Area Reduction, Volume, Perimeter, etc.

Selecting a data point on a graph will take you to the relevant assessment that added this data.



## New Wound Assessments

From either the **Wound Timeline** or the **Patient Timeline**, a new assessment can be created. Selecting the  button will cause a new window to appear, so the assessment can be created.

**Note:** the list of assessment types and data fields contained within is configured by the Silhouette system administrator.

Select the required assessment type from the list, and fill in the details. When you have finished, **Save** the assessment and it will be added to the **Wound Timeline**.

## Assigning SilhouetteStar Captured Images

Images captured using the SilhouetteStar are stored in a portfolio. These images need to be assigned to assessments (usually Wound Assessments) to enable tracing and tracking of healing.

To assign the images, create a new assessment (or edit an existing one), and select the **Add Images (+)** button on the images field.

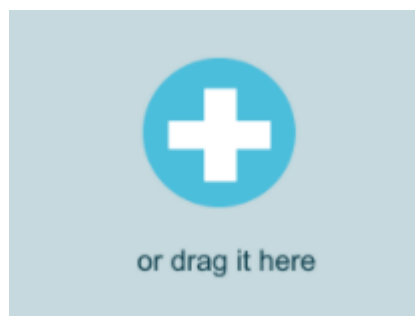

This will open the Portfolio. Select the images you want (they will be highlighted with a blue border), and select **Ok**.

Portfolio

OK

Assign image(s) to Wound Images for Wound C: Forehead, Left Lateral

Captured images



OK

To delete images, open the **Portfolio** (by selecting the camera icon in the patient sidebar) and select the rubbish bin icon on the images you want to remove. The deleted image will gray out and show an **Undo** link for 5 seconds, in case the wrong image was selected by accident.

Use the link underneath the image to remove images from the assessment. If it was just added to the assessment, the link will read **Return to portfolio**, and using it will return the image to the Portfolio. If the image had been added before, the link will read **Remove from assessment**, and using it will permanently delete the image from Silhouette.

## Wound Images

Thumbnails of all the images for the assessments are shown:

**Wound B - Wound Assessment**

🕒 30-10-2017 16:43:59

**Wound Images**

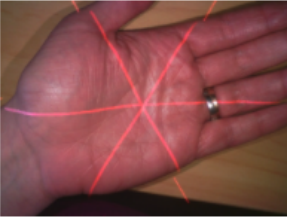







<b>Area:</b> 1486mm <sup>2</sup>	<b>Island Area:</b> -	<b>Perimeter:</b> 159mm	<b>Length:</b> 64mm
<b>Width:</b> 40mm	<b>Max Depth:</b> 5mm	<b>Mean Depth:</b> 1mm	<b>Ruler:</b> -

The measurements shown underneath the images always pertain to all the images. To see the measurements for just one image, open it in the image viewer, which will display the individual measurements.

For more information about capturing images for circumferential wounds, see [Taking a Multiple Image Measurement](#).

To open the full-screen image viewer, select the image in the assessment view. In the Image viewer you can control what you see on the image and also export the image.

- Show or hide the lasers. Select the **Show/Hide Lasers** button in the full-screen view 
- Show or hide the laser detections (the points where the software has detected the laser). Select the **Show/Hide Laser Detections** button in the full-screen view 
- Show or hide the wound outline. Select the **Show/Hide Outline** button in the full-screen view 
- Show or hide the rulers. Select the **Show/Hide Rulers** button in the full-screen view 
- Show or hide the axes. Select the **Show/Hide Axes** button in the full-screen view 
- Export the image. Select the **Export Image** button in the full-screen view 

**Edit** the assessment to work with the tracings on the image.

- Once the assessment is open in Edit mode then select the image to open the image tracer.
- Edit the image by redrawing or adjusting the wound outline. [See "Tracing Wound Outlines"](#) for more information on editing tracing.

## Tracing Wound Outlines

Select the image thumbnails on an assessment to open the trace screen and trace the wound outlines. The assessment must be in edit mode (i.e. not read mode) to trace. Selecting an image in read mode will open the image viewer without the trace tools present.

To trace wounds, zoom into the image either by selecting the zoom image button, using the scroll wheel on your mouse, or by using pinch to zoom gestures on a touch interface. Once zoomed the image can be panned by grabbing part of the image away from the on-screen pencil.

Trace the wound outline by dragging the pencil to the edge of the wound. Hold the pencil in one spot to start the tracing and then move the pencil along the edge of the wound.

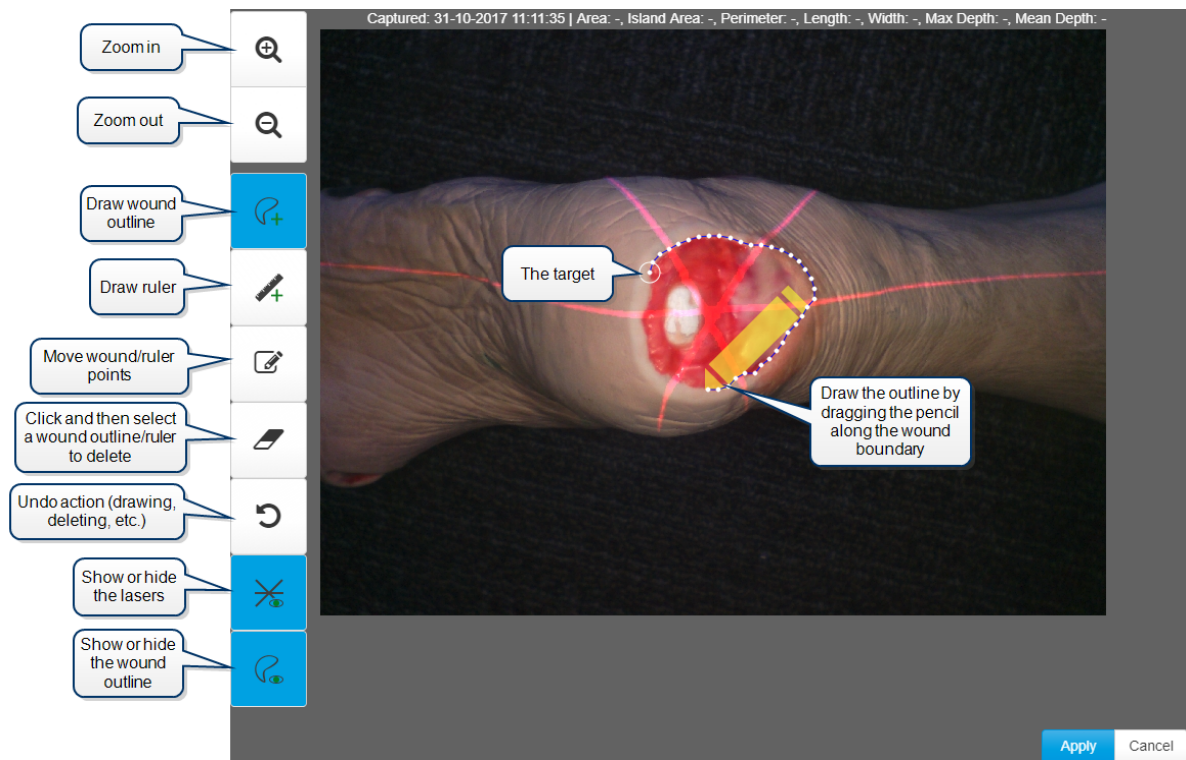

Draw in one direction until the circular target (the starting point) is reached:

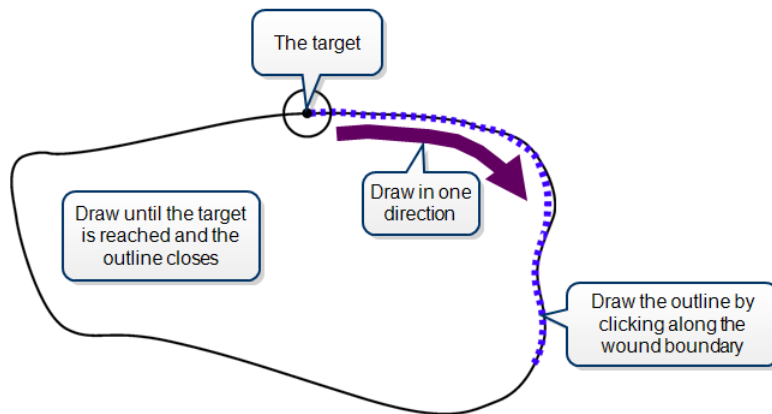

If you wish to delete the whole outline, select the **Delete** button, then on the outline you wish to delete. To start drawing again, select the **Draw outline** button.

When tracing the wound boundary, it is important to draw in one direction. For example, draw in the clockwise direction or the counterclockwise direction, but don't draw in one direction then switch to the other direction. Ensure that the different parts of the outline do not overlap:

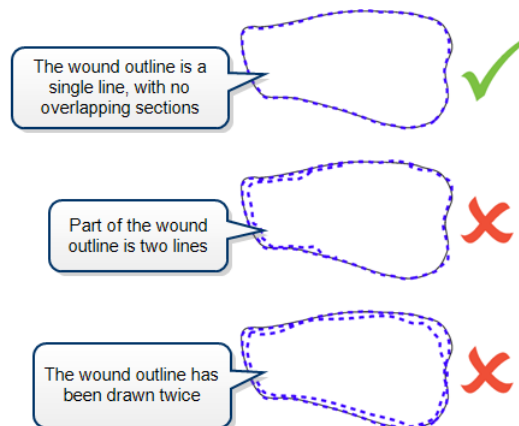

## 74 • Tracing Wound Outlines

Silhouette will advise you if there is a problem with the tracing of a wound boundary with a message at the top of the image window:

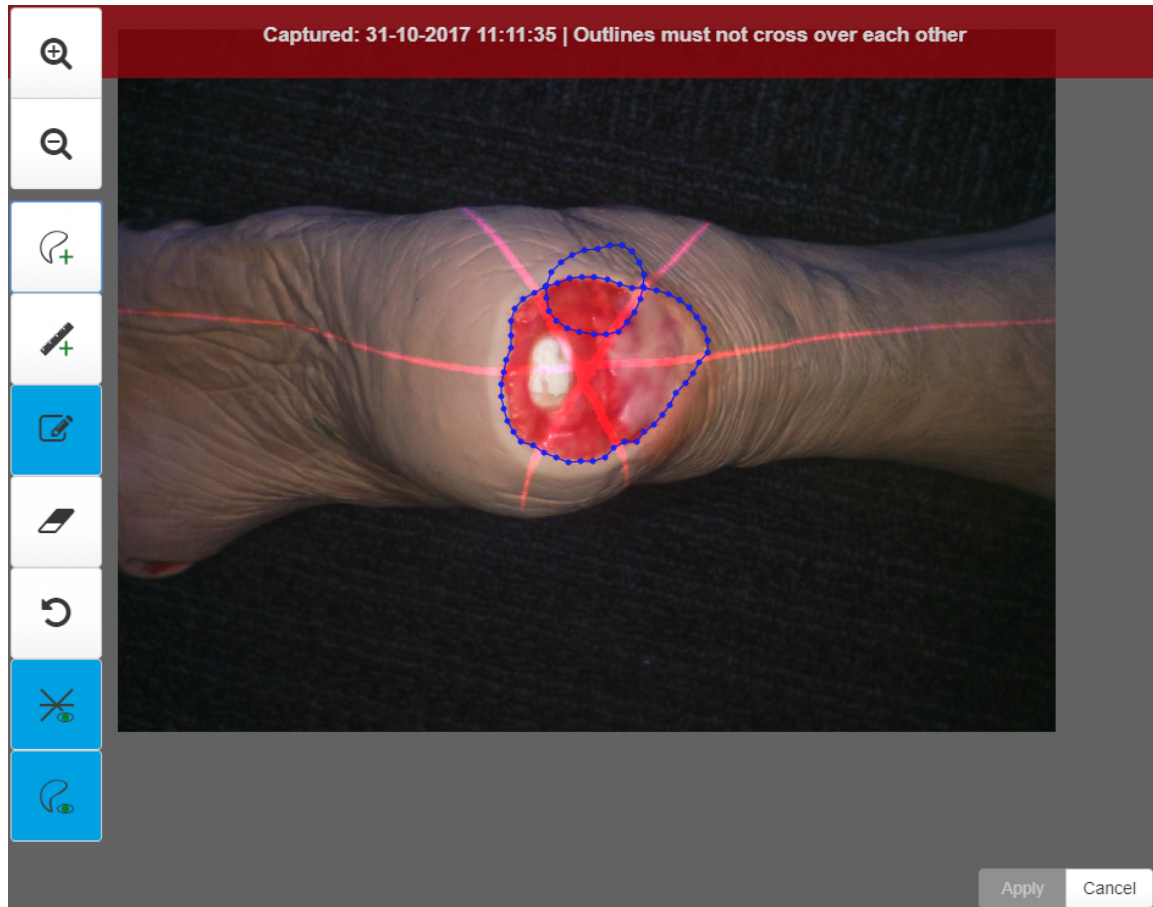

Once you have reached the target, the outline will close and the wound's area and perimeter will be displayed:

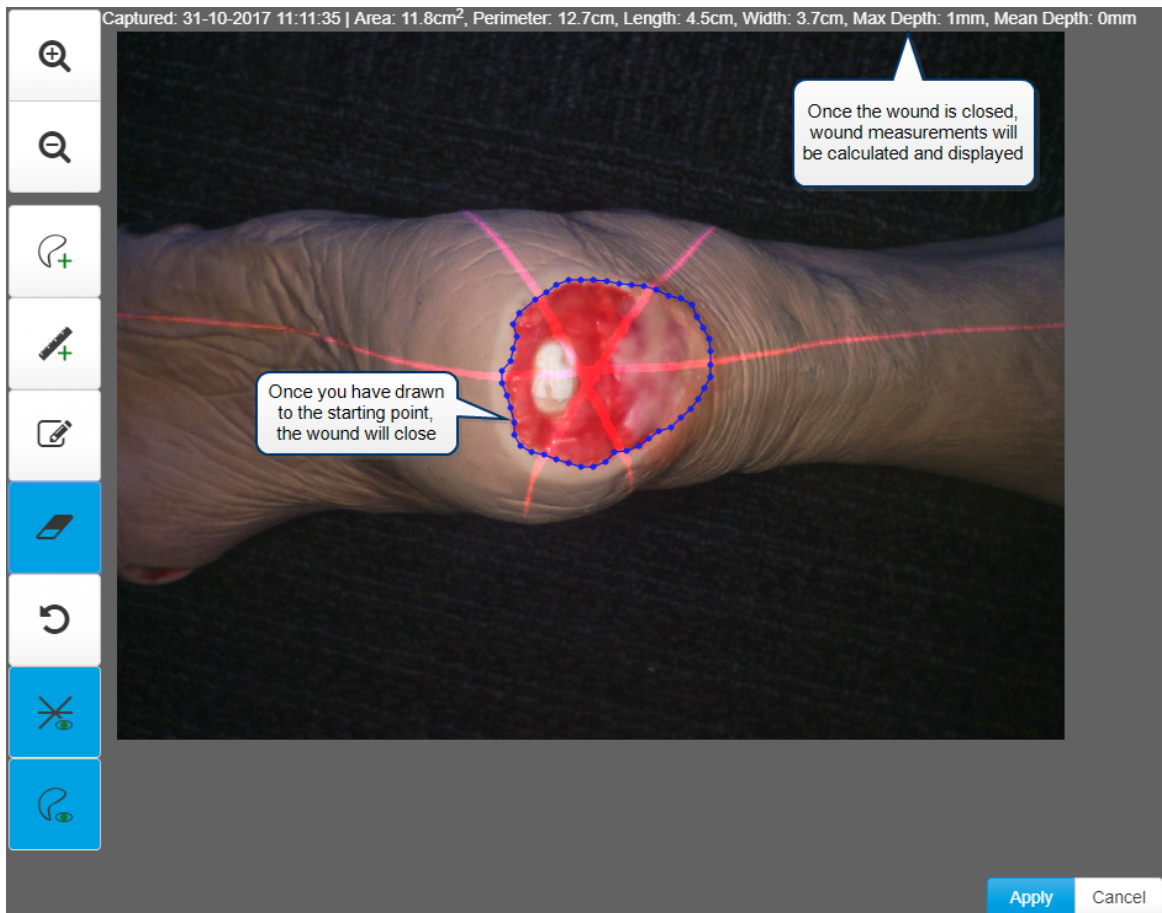

Maximum depth and volume may also be displayed for some wounds.

You can also draw outlines of any wound fragments or islands. To do this, select the **Draw outline** button and trace the island or fragment, ensuring the outline is closed. Silhouette automatically regards outlines inside the main wound outline as islands and those outside the main outline as fragments:



## 76 • Tracing Wound Outlines

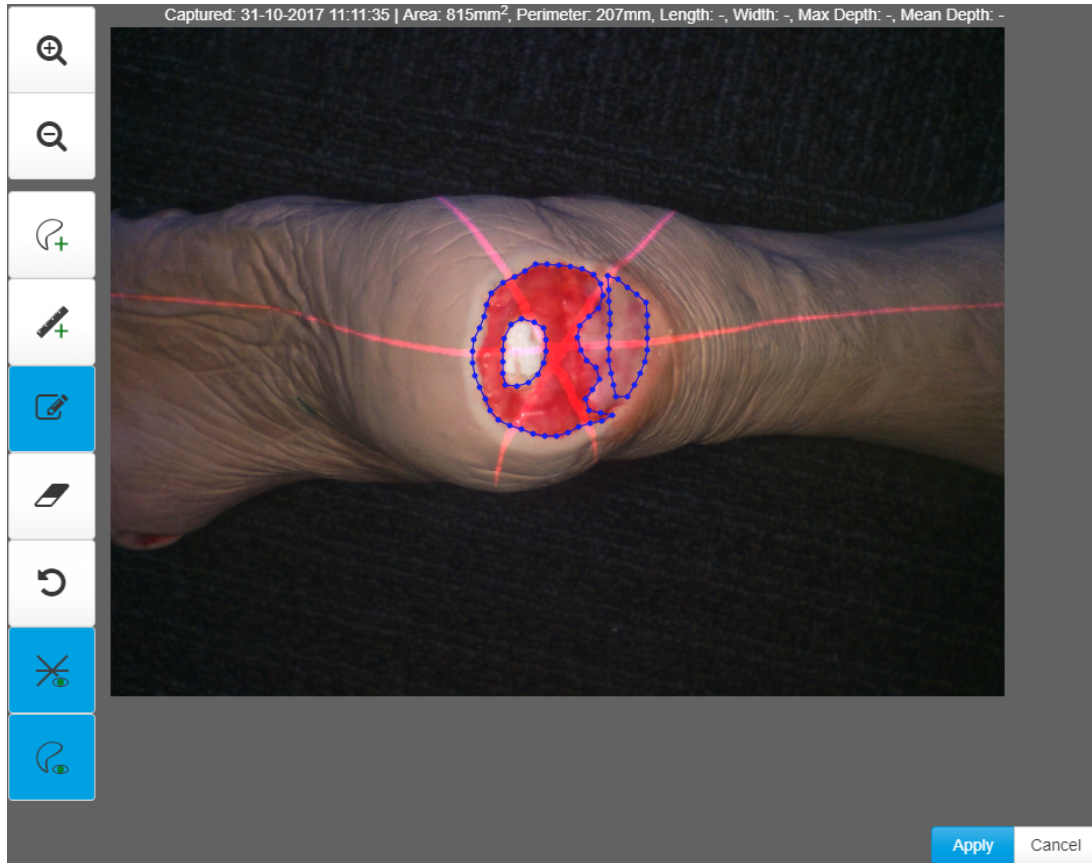

When you outline islands and/or fragments for a wound, maximum depth and volume will not be displayed for that wound.

You can also draw rulers on the image to measure different parts of the wound. To do this, select the **Draw rulers** button and then select and drag the **pencil** across the distance you wish to measure. When you release the **pencil**, a menu will appear showing you the distance measured:

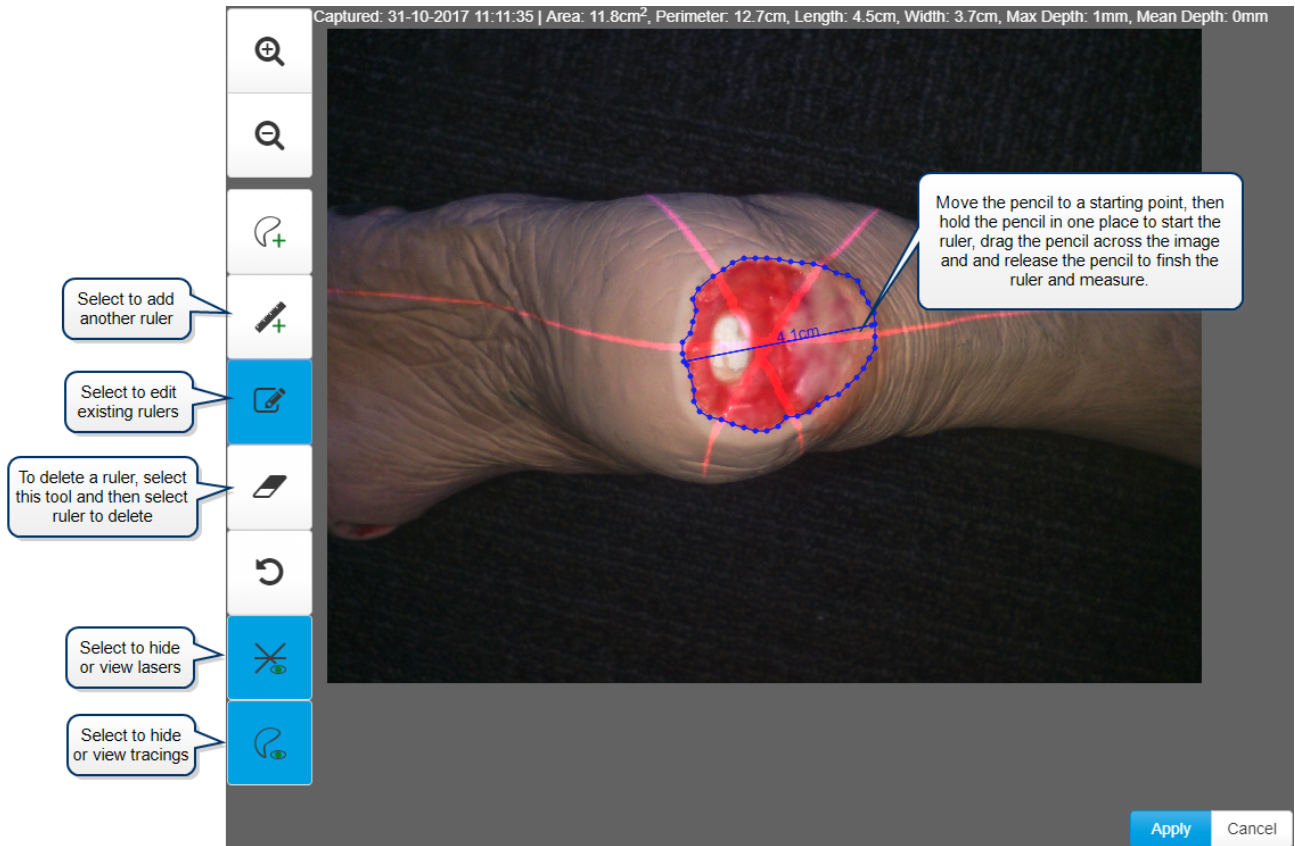

You can draw additional rulers, if required. If you wish to edit a ruler, select the **Edit** button, then select one of the end points of a ruler and drag to move it.

Once you have finished outlining and measuring all the wounds, select the **Apply** button. The apply button accepts the tracings but the tracings are not saved until the assessment is saved.

If you do not trace an image, it will be regarded as a reference image. Reference images are useful if you wish to capture an image of the surrounding tissue to demonstrate, for example, redness or swelling extending beyond the measured wound image.

## The SilhouetteCentral Admin UI

The options available under the SilhouetteCentral **Admin** in the Application Menu are dependent on your permissions. For most clinical users the only option will be to view and edit your own profile information ([See "Profile"](#)), including the ability to change your password ([See "Changing Your Password"](#)).

More information about other Silhouette Admin features see the Silhouette Administration Guide.

## Profile

In the **Profile** screen, you can:

- Change the password you use to log on to Silhouette. See [Changing Your Password](#).
- Change other account settings, such as your name, contact details or email address.



You may not be able to access the Account screen if your user account is administered centrally via your IT infrastructure. In this case you should contact your systems administrator if you need to change any details of your user account displayed within Silhouette.

## Changing Your Password

To change your Silhouette password:

1. Navigate to the **Admin -> Profile** screen.
2. Select the **Change Password** button.
3. Enter your existing password in the **Current Password** box.
4. Enter your new password in both the **New Password** and **Confirm Password** boxes.
5. Select the **Save** button to update the system with your new password.

Note that user names and passwords are used across the Silhouette Product Suite, so you will also need to use the new password when logging in to SilhouetteCentral, SilhouetteLite or SilhouetteLite+.

## System Requirements and Operating Conditions

Not all system specifications are listed in this section. See the system specification sheet from ARANZ Medical for further information.

### SilhouetteCentral Web Application - Minimum Requirements

Web Browsers Supported

Safari, IE, Edge, Firefox, Chrome

Note: The web application is not designed to work on phone screens. An iPad mini or larger is recommended.

### SilhouetteStar 2 - Minimum Requirements

Wi-Fi Network Support

Wi-Fi 802.11 a,b,g at 2.4 GHz

Wi-Fi Security Supported

WPA/WPA2-PSK

Note: Network passwords must be at least 8 characters long

Minimum bandwidth required

14 Mbps uplink and downlink between the exam room and the SilhouetteCentral server.

Maximum network latency

300 ms round trip between the exam room and the SilhouetteCentral server.

Lighting

100 lux minimum

400 lux nominal (normal office)

1000 lux max (bright office)

Operating Temperature

10 C (50 F) min

30 C (86 F) max

Operating Humidity

0% RH min

80% RH max

Storage Temperature

-5 C (23 F) min

50 C (122 F) max

## 82 • SilhouetteLite and SilhouetteLite+ App - Minimum Requirements



The SilhouetteStar 2 uses Wi-Fi to send captured images to SilhouetteCentral. For a reliable user experience, the Wi-Fi network at the point of care (i.e. in the exam rooms) must be reliable. A reasonable heuristic for the Wi-Fi performance required is that the Wi-Fi should support a 10 minute video conference session with no glitches and good video quality.

The bandwidth and latency requirements above are minimum recommendations for end-to-end network performance requirements based on testing. They don't cater for the number of other services using the network or packet loss in the network. As part of the deployment it is recommended that some testing be carried out to confirm reliable and timely performance of the system.

### SilhouetteLite and SilhouetteLite+ App - Minimum Requirements

iOS version	iOS 10 or newer
Device support	iPhone 5s and later The application interface is designed primarily for iPhone Plus and iPad Mini devices but has been tested on a wider range of device sizes.
Security	Passcode / Touch ID enabled It is recommended that passcode / Touch ID is enabled on the device. Doing so enables the Apple to encrypt the SilhouetteLite files, protecting them from untrusted access.
Maximum number of patients	4000
Maximum number of images per image capture field	10

### SilhouetteLite+ Sensor - Operating Conditions

x offset	-12 mm to +20 mm Horizontal offset for placement of the SilhouetteLite+ sensor optics relative to the device optics.
y offset	-12 mm to +30 mm Vertical offset for placement of the SilhouetteLite+ sensor optics relative to the device optics.
Sensor Operating Temperature	0°C to 40°C (32°F to 104°F)
Sensor Charging Temperature	0°C to 45°C (32°F to 113°F)
Sensor Storage Temperature	-5°C to 60°C (23°F to 140°F) for < 2 hours 0°C to 45°C (32°F to 113°F) for up to 1 month

0°C to 35°C (32°F to 95°F) for > 1 month



## Troubleshooting

The troubleshooting section provides solutions for common problems you may have using the Silhouette clinical tools.

- [Recovering Forgotten Password](#)
- [Troubleshooting SilhouetteLite+](#)

## Recovering Forgotten Password

If you have forgotten your password, select the "Forgot your Password?" link on the log on screen. If you do not see this link, your administrator may have chosen to disable this feature, in which case contact your system administrator for further advice on how to regain access to your account.



The screenshot shows a login interface with two input fields: "User Name" and "Password". Below the "Password" field is a blue "Login" button. To the right of the "Login" button is a blue link that says "Forgot your password?".

Once the "Forgot your password?" link is selected you will be prompted to enter your email address. You should enter the email address that is associated with your Silhouette user name.

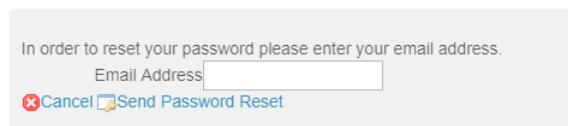

The screenshot shows a prompt: "In order to reset your password please enter your email address." Below this is an input field labeled "Email Address". At the bottom left are two buttons: "Cancel" (with a red 'x' icon) and "Send Password Reset" (with a blue envelope icon).

You will get a message that an email with instructions to reset your password has been sent to the email address you specified.

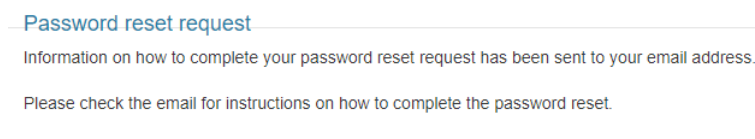

The screenshot shows a confirmation message with the following text:
 

- Password reset request**
- Information on how to complete your password reset request has been sent to your email address.
- Please check the email for instructions on how to complete the password reset.

When you check your email account and receive the email sent by Silhouette you will find a link that can be used to reset your password. Selecting the link will load the Silhouette website and prompt you to enter a new password.

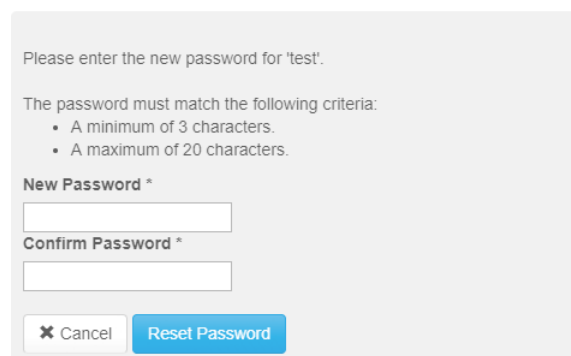

The screenshot shows a form for creating a new password. It includes the following elements:
 

- Text: "Please enter the new password for 'test'."
- Text: "The password must match the following criteria:"
- List of criteria:
  - A minimum of 3 characters.
  - A maximum of 20 characters.
- Input field: "New Password \*"
- Input field: "Confirm Password \*"
- Buttons: "Cancel" (with a red 'x' icon) and "Reset Password" (in blue).

## 86 • Recovering Forgotten Password

You will receive a confirmation that your password has been changed and you can now proceed to log on with the new password.

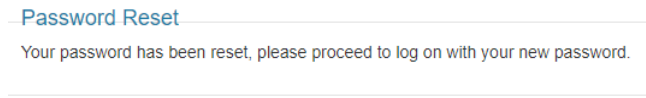

If you receive a password reset request email and do not remember requesting it, an additional link in the email may (depending upon system configuration) be provided that allows you to cancel the password reset request so any other person who manages to view the email can not reset your password.

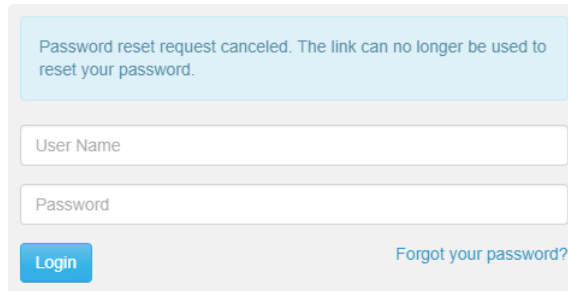

The image shows a login form with a light blue background. At the top, a message box states: "Password reset request canceled. The link can no longer be used to reset your password." Below this are two input fields: "User Name" and "Password". At the bottom left is a blue "Login" button, and at the bottom right is a blue link that says "Forgot your password?"

In some circumstances you may get a password reset email that indicates your user account is not able to have its password reset via email. In this scenario contact your system administrator for further instructions on how to reset your password.

## Troubleshooting SilhouetteLite+

### **The SilhouetteLite+ sensor doesn't show in the SilhouetteLite+ app**

If the SilhouetteLite+ sensor either doesn't show in the 'Select Sensor' list or if the app reports 'Sensor Not Found' then try placing the sensor on charge. A 10 minute charge should give enough charge for an assessment to be completed.

The sensor must be removed from the charger before it will communicate with the app again.

### **The SilhouetteLite+ app is not uploading data to SilhouetteCentral**

Go through the following checklist to confirm that the app can upload data to SilhouetteCentral:

- Check that your device has a WiFi or a Mobile Data network connection.
- If using Mobile Data then check the settings app to confirm that SilhouetteLite+ is allowed to use Mobile Data.
- Check that your device can reach your instance of SilhouetteCentral by putting the SilhouetteLite+ sync URL into the web browser on the device.
- Check with your system admin to confirm your user account isn't locked or disabled.

If the problem persists then open the settings menu in the app (cog icon in the Patients screen) and select Logs. There is an email link in the logs screen and this can be emailed to your system administrator to provide further help.

## CTEULA and Terms of Use

This section provides the Silhouette license information, consisting of:

- [Conditions of Transfer and End-User License Agreement](#)
- [ARANZ Medical Limited – Silhouette® Product Suite Terms of Use](#)

### Conditions of Transfer and End-User License Agreement for ARANZ Medical Limited and Silhouette® Product Suite

Effective Date: 1 July 2017

**IMPORTANT – READ CAREFULLY:** This Conditions of Transfer and End User License Agreement (CTEULA) constitutes a legal agreement between You and ARANZ MEDICAL LIMITED, covering (1) the sale or leasing of one or more units of **Silhouette Hardware**, and (2) the licensing of **Silhouette Software**, in the SILHOUETTE® product suite. This CTEULA also covers the circumstance in which one or more unit(s) of Silhouette Hardware is/are loaned to You for evaluation, research or other purposes.

**PLEASE READ THIS CTEULA CAREFULLY BECAUSE USING THE SILHOUETTE HARDWARE OR THE SILHOUETTE SOFTWARE WILL BE DEEMED TO BE ACCEPTANCE THAT THEY ARE BEING USED ON THE FOLLOWING TERMS.**

**1. Defined Terms.** As used in this CTEULA and in the Terms of Use, the following terms have the following meanings:

**AML** means ARANZ Medical Limited.

**Image Capture Unit** means an image capture device, and includes a Silhouette Device, but also includes a smart phone or tablet provided by You running SilhouetteLite or SilhouetteLite+.

**Module** means an add-on, option or feature, which is associated with a Silhouette Software product but is licensed for an additional license fee.

**Upgrade** means a subsequent release of a Silhouette Software product which AML may offer to license holders with a current paid up Support Contract at no additional license fee and may include bug fixes and new functionality.

**Order Form** means the contract, quotation or purchase order accepted by AML designating which unit(s) of Silhouette Hardware (if any) are being sold, leased or loaned to You and which units of Silhouette Software (if any) are being licensed to You.

**Point of Care Access License** means a license to SilhouetteCentral that permits specified Image Capture Units to communicate with an instance of SilhouetteCentral.

**Products** means, collectively, any Silhouette Device or Silhouette Accessory sold, leased or loaned to You, any Silhouette Software licensed to You, and any Support or Services purchased by You.

**Services** means any additional services purchased by You from AML (and/or its distributor) over and above those services included in Your **Support Contract** (see Part 4 of the Terms of Use for more detail).

**Silhouette Accessory** means accessory hardware produced by AML, other than the Silhouette Devices, and includes the SilhouetteLite+ Sensor.

**SilhouetteCentral** means the executable code version of the application software for the storage and organization of wound data, produced by AML under the SILHOUETTECENTRAL™ trademark.

**SilhouetteConnect** means the executable code version of the application software for wound image processing and storage on a personal computer, laptop or tablet provided by You, produced by AML under the SILHOUETTECONNECT™ trademark.

**Silhouette Device** means one or more image capture devices in the Silhouette product suite produced by AML, including SilhouetteStar.

**Silhouette Hardware** means, collectively, the Silhouette Device(s) and the Silhouette Accessory(ies).

**SilhouetteLite** means the executable code version of the application software for wound image and data capture and processing, produced by AML under the SILHOUETTELITE™ trademark.

**SilhouetteLite EULA** means the End User License Agreement that the end user agrees to when he/she/it downloads SilhouetteLite or SilhouetteLite+ from the Apple App Store.

**SilhouetteLite+** means the executable code version of the application software for wound image and data capture and processing with the SilhouetteLite+ Sensor, produced by AML under the SILHOUETTELITE+™ trademark.

**SilhouetteLite+ Sensor** means the range finder accessory device, and associated battery charger, produced by AML under the SILHOUETTELITE+ SENSOR™ trademark.

**Silhouette Software** means collectively SilhouetteCentral and SilhouetteConnect, and also includes Upgrades and Modules with respect to each of same. The "Silhouette Software" also includes any documentation provided or made available to You by AML in connection with and pertaining to the Silhouette Software, whether in printed or electronic format, and any associated media or printed materials pertaining to the Silhouette Software. For clarity, as used herein, the term "Silhouette Software" does not include SilhouetteLite or SilhouetteLite+, as those products are licensed under the terms of SilhouetteLite EULA.

**SilhouetteStar** means the SILHOUETTESTAR™ image capture device.

**Support** means the support services that AML provides to license holders of the Silhouette Software who have paid for a Support Contract for the current support period (see clause 12 and the Terms of Use for more detail).

**Support Contract** means the contract that the holder of a license of the Silhouette Software must purchase as a precondition to receiving Support and Updates during a designated support period (see clause 12 and the Terms of Use for more detail).

**Terms of Use** means the ARANZ Medical Limited Silhouette® Product Suite Terms of Use, which are supplemental to and incorporated by reference into this CTEULA, as such Terms of Use may be revised from time to time.

**You or Your** means the person or entity that purchases, leases or borrows Silhouette Hardware and/or holds a license of the Silhouette Software.

2. **Cover:** This CTEULA applies to all Products sold, leased, loaned or licensed by AML (and/or one of AML's distributors) to You. The Order Form will designate whether and which units of Silhouette Hardware are being sold, leased or loaned. The Order Form will also designate whether and which units of Silhouette Software (including any Modules) are being licensed to You. This CTEULA incorporates the Terms of Use all of which Terms of Use shall apply between AML and You as though set forth in this CTEULA in full.
3. **Risk:** The risk of loss to the Products shall pass to You immediately upon delivery of the Silhouette Hardware unless otherwise agreed in writing.
4. **Delivery.** Delivery of the Silhouette Hardware shall occur when the Silhouette Hardware arrives and is signed for at the address shown on the Order Form.
5. **Title:** In the case of sale of one or more units of Silhouette Hardware, ownership of the Silhouette Hardware shall not pass to You, nor shall You have a license to use any Silhouette Software until You have paid for the Silhouette Hardware in full and also paid all license fees owing for the Silhouette Software. In the case of a lease or loan of one or more unit(s) of the Silhouette Hardware, ownership of the Silhouette Hardware shall at all times remain with AML (or its distributor in instances where AML's distributor has made the lease or loan), and, at the expiration or termination of the lease or loan term, You shall, at Your expense, return the Silhouette Hardware to AML (or its distributor, as the case may be) in the same condition as at the beginning of the term, reasonable wear and use excepted.
6. **Non-Payment:** Where You fail to pay when due either the purchase price for the Silhouette Hardware, or any lease payment, license fee or other amount owing to AML (and/or its distributor), AML (and/or its distributor) may charge, and You shall be liable to pay, interest on any overdue account calculated on a daily basis from the due date until actual payment at an interest rate equal to the lesser of (i) 5% above the the "U.S. Prime Rate", as adjusted from time to time, as published in the Wall Street Journal, or (ii) the highest rate of interest permitted by law. In addition, You agree to reimburse AML (and/or its distributor) for any costs and expenses, including legal fees, incurred by AML (and/or its distributor) in collecting any amounts You fail to pay when due to AML (and/or its distributor). Further, You agree to return the Silhouette Hardware to AML (and/or its distributor) at Your expense if requested to do so by AML (and/or its distributor) following non-payment of any amount owing by You to AML (and/or its distributor) for the purchase or lease of Silhouette Hardware and without limiting any other right AML (and/or its distributor) may have.
7. **Taxes:** All payments under this CTEULA shall be made free of deduction or withholding. In the event that You become liable to deduct or withhold an amount by way of tax or otherwise from payments due under this Agreement, You shall pay such additional amount as will be necessary to ensure that the price for the Products received by AML (and/or its distributor) equals the amount that would otherwise have been received in the absence of that deduction or withholding.

## 90 • CTEULA and Terms of Use

- 8. License:** If the Order Form includes one or more licenses of Silhouette Software, AML grants You a non-exclusive, non-transferrable license to use the then current released version of the specified Silhouette Software Product in accordance with this CTEULA and this license shall continue for the term described in Paragraph 9, unless sooner terminated or revoked under the terms of this CTEULA. In addition to any other rights AML may have, AML may revoke the Silhouette Software licenses granted by notifying You in writing if You fail to pay when due, the purchase price for the Silhouette Hardware, or any lease payment, license fee or other amount owing to AML, or shall breach any provision of the CTEULA. Upon such revocation, or upon the expiration or termination of a Silhouette Software license, AML shall have the right to block Your access to and use of the licensed Silhouette Software or any part thereof. **“Use”** of the Silhouette Software means loading, installing, or running the Silhouette Software on the hardware provided by You, meeting a specification provided by AML; provided, however, in the case of a license of SilhouetteCentral with hosting by AML, **“Use”** means access to and use of the hosted instance.
- 9. Software License Term and Renewal:** The license granted under this Agreement may be either for a Fixed Term or for a Continuous Term as follows:
- (a) If the Order Form specifies a fixed term, then this license is for the fixed term specified on the Order Form (**Fixed Term**) commencing on the date the license is issued. In such event, the renewal of the Fixed Term will be governed by clause 10 below. If the Order Form fails to specify a Fixed Term or a Continuous Term, the license shall be deemed to be for a Fixed Term of one month commencing on the date the license is issued.
  - (b) If the Order Form specifies a Continuous Term, then this license is for a Continuous Term as specified in the Order Form (**Continuous Term**) commencing on the date the license is issued.
  - (c) For clarity, where more than one Silhouette Software Product is licensed to You, the Order Form may specify a different Fixed Term and/or a Continuous Term for each.
  - (d) Whether for a Fixed Term (or any Renewed Term thereof) or a Continuous Term, the license granted under this Agreement is subject to termination under the circumstances described in clause 8.
- 10. Renewal:** If Your license is for a Fixed Term, then at the expiration of the Fixed Term (and any subsequent Renewed Term), AML may offer to renew Your license of the Silhouette Software for an additional term (**Renewed Term**) provided:
- (a) You are not in breach of this Agreement;
  - (b) AML has received from You in cleared funds the then current license fee for the Renewed Term; and
  - (c) You agree to any variation of this Agreement specified by AML in accordance with clause 23.
- AML may offer You a Renewed Term by sending You a renewal invoice for the license fee for the Renewed Term during the last ninety (90) days of the then current term of Your license. You may accept such offer by paying the renewal invoice when due and agreeing to any such variations in the manner specified by clause 23. The Renewed Term may be effected by the issue of an executable or license file over the internet. If AML does not offer a Renewed Term or if You do not accept a Renewed Term in the above manner, the license of the Silhouette Software shall terminate at the end of the initial Fixed Term or the initial Fixed Term as previously renewed.
- 11. Restrictions on Use:** You agree not to:
- (a) translate, adapt, reverse-engineer or modify the Silhouette Hardware or the Silhouette Software, or do anything to circumvent the operation of the Silhouette Hardware or the Silhouette Software, or combine or integrate the Silhouette Hardware or the Silhouette Software with any other products;
  - (b) separate any component of the Silhouette Software or Silhouette Hardware for use with other than the hardware for which a license has been granted;
  - (c) lend, rent, lease, transfer, assign or otherwise deal in the Products without the prior written consent of AML.
  - (d) export or extract data from the Silhouette Software, except through a product or service provided by AML.
  - (e) use any of the Products outside the field of human medicine or for any use or purposes for which governmental approvals have not been obtained.
- Without limiting the generality of the foregoing, you agree that the Products may not be exported or re-exported (a) into any U.S.-embargoed countries or (b) to anyone on the U.S. Treasury Department's Specially Designated Nationals List or the U.S. Department of Commerce Denied Persons List or Entity List. By using the Products, you represent and warrant that you are not located in any such country or on any such list. You also agree that you will not use these products for any purposes prohibited by United States law, including, without limitation, the development, design, manufacture, or production of nuclear, missile, or chemical or biological weapons.

In addition, (1) each license of SilhouetteConnect is restricted to use only on a single unit of computer equipment used by a single person at any time, and consisting of a personal computer, laptop or tablet, and You agree not to exceed this limitation, and (2) each Point of Care Access License will specify the specific Image Capture Unit(s) which may connect to an instance of SilhouetteCentral via that Point of Care Access License, and You agree not to circumvent this restriction.

12. **Upgrades and Support:** AML may offer You Upgrades when they are released. In cases where new versions are offered with respect to the Silhouette Software, but are not accepted by You, AML shall have no obligation to provide Support for older versions. The Order Form may describe Upgrades and/or Support that AML has agreed to provide You with respect to the Products. Except as otherwise provided in the Order Form, Upgrades and Support will be available to You only if offered by AML and purchased by You at AML's applicable rates. AML may offer You Modules from time to time, subject to Your payment of such additional license fees and agreement to any terms and conditions applicable to the Modules. All Upgrades and Modules will form part of the Silhouette Software and must only be used in accordance with this CTEULA.
13. **Protection of Proprietary Rights:** You acknowledge that all right, title and interest in the Silhouette Software and all Proprietary Rights in the Silhouette Hardware and the Silhouette Software are vested in AML or its licensors, and You agree that You will not dispute such ownership nor claim any intellectual property rights relating to the Silhouette Hardware or the Silhouette Software or any enhancements or modifications of the Silhouette Hardware or the Silhouette Software. For the purposes of this CTEULA, "Proprietary Rights" means all intellectual or industrial property rights in the Silhouette Hardware and the Silhouette Software and all rights to patents, trademarks, trade names, inventions, designs, trade secrets, copyright and know-how relating to the origin, manufacture, programming, operating and/or servicing of the Silhouette Hardware and the Silhouette Software and any enhancements or modifications of the Silhouette Hardware or the Silhouette Software. You must maintain all intellectual property notices appearing on the Products and must not remove the same. You must notify AML immediately if You know of any circumstances that suggest that any person may have unauthorised knowledge, possession or use of the Products.
14. **Warranty - Silhouette Hardware:** If You have purchased or leased one or more unit(s) of the Silhouette Hardware, the Terms of Use sets forth the Limited Warranty applicable to the Silhouette Hardware. Except as set forth in the Terms of Use, all other representations or warranties (statutory, express or implied except any which may not lawfully be excluded) with respect to the Silhouette Hardware are expressly excluded. Without prejudice to the generality of the foregoing, the implied warranties of merchantability and fitness for a particular purpose are excluded.
15. **Warranty - Software:** The Silhouette Software is licensed to You "as is" and all representations or warranties (statutory, express or implied except any which may not lawfully be excluded) are expressly excluded. Without prejudice to the generality of the foregoing, the implied warranties of merchantability and fitness for a particular purpose are excluded. You acknowledge that the Silhouette Software operates in a predictive manner relative to input of which AML has no control over the collection, use or interpretation, and You accept the entire risk as to the use and the results of the use of the Silhouette Software in the terms of correctness, accuracy, reliability and performance. You also accept the entire risk as to any conflict between Silhouette Software and other software on the hardware on which the Silhouette Software is installed.
16. **Data:** If the Order Form includes a license of SilhouetteCentral with data to be hosted by You, You will be exclusively responsible for security and integrity of data, including regular back up of data. If the Order Form includes a license of SilhouetteCentral with data hosted by AML, then upon termination of Your license of SilhouetteCentral, AML will take Your instance of SilhouetteCentral off line, but will offer You an archive of images and wound assessment records, provided You pay for AML's usual commercial charges for the cost of preparing the archive. This archive will be in the form of jpg images, an export of the wound measurement data in a CSV (comma separated value) format file, and an export of SilhouetteCentral format data. This archive will be provided on an industry standard media (such as DVD) that AML will select at the time.
17. **Government Licenses of Software.** The Silhouette Software and related documentation are "Commercial Items", as that term is defined at 48 C.F.R. §2.101, consisting of "Commercial Computer Software" and "Commercial Computer Software Documentation", as such terms are used in 48 C.F.R. §12.212 or 48 C.F.R. §227.7202, as applicable. Consistent with 48 C.F.R. §12.212 or 48 C.F.R. §227.7202-1 through 227.7202-4, as applicable, the Commercial Computer Software and Commercial Computer Software Documentation are being licensed to U.S. Government end users (a) only as Commercial Items and (b) with only those rights as are granted to all other end users pursuant to the terms and conditions herein. Unpublished-rights reserved under the copyright laws of the United States.



- 18. Liability:** TO THE EXTENT NOT PROHIBITED BY LAW, IN NO EVENT SHALL AML BE LIABLE FOR PERSONAL INJURY OR ANY INCIDENTAL, SPECIAL, INDIRECT, OR CONSEQUENTIAL DAMAGES WHATSOEVER, INCLUDING, WITHOUT LIMITATION, DAMAGES FOR LOSS OF PROFITS, LOSS OF DATA, BUSINESS INTERRUPTION, OR ANY OTHER COMMERCIAL DAMAGES OR LOSSES, ARISING OUT OF OR RELATED TO YOUR USE OR INABILITY TO USE THE PRODUCTS, HOWEVER CAUSED, REGARDLESS OF THE THEORY OF LIABILITY (CONTRACT, TORT, OR OTHERWISE) AND EVEN IF AML HAS BEEN ADVISED OF THE POSSIBILITY OF SUCH DAMAGES. SOME JURISDICTIONS DO NOT ALLOW THE LIMITATION OF LIABILITY FOR PERSONAL INJURY, OR OF INCIDENTAL OR CONSEQUENTIAL DAMAGES, SO THIS LIMITATION MAY NOT APPLY TO YOU. In no event shall AML's total liability to You for all damages (other than as may be required by applicable law in cases involving personal injury) exceed the amount of fifty US Dollars (US\$50.00). The foregoing limitations will apply even if the above stated remedy fails of its essential purpose.
- 19. Compliance with Law:** You will not use the Products for any unlawful purpose or in furtherance of any illegal activity. You warrant that You will comply with all applicable federal, state and local laws, executive orders, and regulations. You further warrant that at all times when using the Products you will have obtained all consents and/or permissions as required by law to receive, transfer, use or provide any personal information, Protected Health Information, and/or other data provided, entered, transferred or received by you using the Products, and that your use of the Products will be conducted in accordance with all applicable laws, including but not limited to HIPAA.
- 20. Notice:** Any notice to be given in terms of this CTEULA must be made in writing or by email sent to the address notified by either party to the other from time to time. Any communication by email will be deemed to be received when transmitted to the correct email address of the recipient and any communication in writing will be deemed to be received when left at the specified address of the recipient.
- 21. Force Majeure:** AML will not be liable to You for any delay or failure of AML to perform its obligations hereunder if such delay or failure arises from cause or causes beyond the reasonable control of AML.
- 22. Assignment:** You may not assign or transfer this Agreement or any of the rights or obligations under this Agreement without the prior written consent of AML.
- 23. Agreement:** This Agreement constitutes the entire agreement of AML and You with respect to the subject matter hereof and supersedes any and all prior negotiations and agreements between AML and You with the exception of terms listed in the Order Form and a non-disclosure agreement that may separately be in force between AML and You. The additional terms set forth in the Order Form and in the Terms of Use are incorporated by reference in this Agreement, and You agree to abide by all of such additional terms. In the event of any conflict between the terms of the Order Form and the terms of this CTEULA, the terms of the Order Form shall govern. This Agreement and/or the Terms of Use may be revised by AML from time to time. By accepting any Renewed Term, by paying Support fees or by accepting any Update or Module offered by AML, You will be deemed to have agreed to, and will be bound by, all the terms and conditions of this Agreement and the Terms of Use in its and/or their then most current form, as posted at [www.aranzmedical.com](http://www.aranzmedical.com). No variation to the terms of this Agreement or the Terms of Use made by You will be binding on AML unless it is in writing and signed by both parties.
- 24. Governing Law:** This Agreement is subject to the laws of New Zealand and You agree to submit to the exclusive jurisdiction of the New Zealand courts.

CTEULA Document Number: 2007-00204, Revision: 11.0

---

## ARANZ Medical Limited – Silhouette® Product Suite Terms of Use

**Effective Date: 1 July 2017**

---

This document sets forth terms of use for the Silhouette® Product Suite, and is divided into the following Parts:

**Part 1: Defined Terms**

**Part 2: Warranty Terms**

**Part 3: Use of Silhouette Software**

**Part 4: Technical Support Policies**

**Part 5: General Terms**

Parts 1 and 5 apply to all Products, whereas Parts 2 through 4 are divided into sections applicable to individual Products, so you should review Parts 2 through 4 and your Order Form to determine the sections of Parts 2 through 4 applicable to the Products you are purchasing, leasing, licensing and/or borrowing from Us. These Terms of Use are supplemental to the Conditions of Transfer and End User License Agreement (CTEULA) applicable to the Products and all of terms of the CTEULA will apply to your purchase, lease, license and/or loan of the Products.

**Part 1: Defined Terms**

As used in these Terms of Use, the following terms have the following meanings:

**AML** means ARANZ Medical Limited.

**Image Capture Unit** means an image capture device, and includes a Silhouette Device, but also includes a smart phone or tablet provided by You running SilhouetteLite or SilhouetteLite+.

**Module** means an add-on, option or feature, which is associated with a Silhouette Software product but is licensed for an additional license fee.

**Upgrade** means a subsequent release of a Silhouette Software product which AML may offer to license holders with a current paid up Support Contract at no additional license fee and may include bug fixes and new functionality.

**Order Form** means the contract, quotation or purchase order accepted by AML designating which unit(s) of Silhouette Hardware (if any) are being sold, leased or loaned to You and which units of Silhouette Software (if any) are being licensed to You.

**Point of Care Access License** means a license to SilhouetteCentral that permits specified Image Capture Units to communicate with an instance of SilhouetteCentral.

**Products** means, collectively, any Silhouette Device or Silhouette Accessory sold, leased or loaned to You, any Silhouette Software licensed to You, and any Support or Services purchased by You.

**Services** means any additional services purchased by You from AML (and/or its distributor) over and above those services included in Your **Support Contract** (see Part 4 of the Terms of Use for more detail).

**Silhouette Accessory** means accessory hardware produced by AML, other than the Silhouette Devices, and includes the SilhouetteLite+ Sensor.

**SilhouetteCentral** means the executable code version of the application software for the storage and organization of wound data, produced by AML under the SILHOUETTECENTRAL™ trademark.

**SilhouetteConnect** means the executable code version of the application software for wound image processing and storage on a personal computer, laptop or tablet provided by You, produced by AML under the SILHOUETTECONNECT™ trademark.

**Silhouette Device** means one or more image capture devices in the Silhouette product suite produced by AML, including SilhouetteStar.

**Silhouette Hardware** means, collectively, the Silhouette Device(s) and the Silhouette Accessory(ies).

**SilhouetteLite** means the executable code version of the application software for wound image and data capture and processing, produced by AML under the SILHOUETTELITE™ trademark.

**SilhouetteLite EULA** means the End User License Agreement that the end user agrees to when he/she/it downloads SilhouetteLite or SilhouetteLite+ from the Apple App Store.

**SilhouetteLite+** means the executable code version of the application software for wound image and data capture and processing with the SilhouetteLite+ Sensor, produced by AML under the SILHOUETTELITE+™ trademark.

**SilhouetteLite+ Sensor** means the range finder accessory device, and associated battery charger, produced by AML under the SILHOUETTELITE+ SENSOR™ trademark.

**Silhouette Software** means collectively SilhouetteCentral and SilhouetteConnect, and also includes Upgrades and Modules with respect to each of same. The “Silhouette Software” also includes any documentation provided or made available to You by AML in connection with and pertaining to the Silhouette Software, whether in printed or electronic format, and any associated media or printed materials pertaining to the Silhouette Software. For clarity, as used herein, the term “Silhouette Software” does not include SilhouetteLite or SilhouetteLite+, as those products are licensed under the terms of SilhouetteLite EULA.

**SilhouetteStar** means the SILHOUETTESTAR™ image capture device.

**Support** means the support services that AML provides to license holders of the Silhouette Software who have paid for a Support Contract for the current support period (see Part 4 below).

**Support Contract** means the contract that the holder of a license of the Silhouette Software must purchase as a precondition to receiving Support and Updates during a designated support period (see Part 4 below).

**Terms of Use** means these ARANZ Medical Limited Silhouette® Product Suite Terms of Use, as such Terms of Use may be revised from time to time.

**You or Your** means the person or entity that purchases, leases or borrows Silhouette Hardware and/or holds a license of the Silhouette Software.

## Part 2: Warranty Terms

### Section 1 - Silhouette Hardware

#### Overview

Each unit of Silhouette Hardware is covered by a limited warranty (the **Limited Warranty**) for a period of 12 months from the date that unit is delivered to you. The Order Form may offer you the option of purchasing a warranty extension, pursuant to which the Limited Warranty may be extended for either an additional 12 or an additional 24 months; but the annual rate charged for the Limited Warranty for a unit of Silhouette Hardware will increase as the age of that unit increases and we reserve the right to not offer warranty extension on any unit of Silhouette Hardware.

#### Scope of Limited Warranty

The Limited Warranty covers failure of the unit of Silhouette Hardware due to manufacturing error or component failure, but expressly excludes any damage or failure that could reasonably be considered to result from: (i) negligence or misuse of the unit of Silhouette Hardware, including dropping of the unit of Silhouette Hardware, (ii) improper operation, use, storage, repair or maintenance of the unit of Silhouette Hardware, (iii) any modification to the unit of Silhouette Hardware not performed by us, or (iv) connection of the unit of Silhouette Hardware to other equipment or software to which it is incompatible.

All other representations or warranties (statutory, express or implied except any which may not lawfully be excluded) with respect to the Silhouette Hardware are expressly excluded. Without prejudice to the generality of the foregoing, the implied warranties of merchantability and fitness for a particular purpose are excluded. We will not be liable to you under the law of tort, contract or otherwise for any direct, indirect or consequential loss or damage, including any loss of profits, however caused, arising out of the use of, loss of use of or disrepair of the Silhouette Hardware. If any limitation of liability is invalid for any reason and we become liable for loss or damage that would otherwise have been excluded, such liability to You for all damages will not (other than as may be required by applicable law in cases involving personal injury) exceed the amount of fifty US Dollars (US\$50.00).

#### Warranty Procedure

In order to receive warranty service for a unit of Silhouette Hardware, the Limited Warranty for that unit of Silhouette Hardware must be in effect on the date on which a warranty claim is lodged by you. You may lodge a warranty claim by email or by calling our technical support line during Support hours. When a warranty claim is lodged, we will assign your warranty claim a Case Number. In most cases it will be necessary for you to ship the unit of Silhouette Hardware to us for evaluation of your warranty claim. If your warranty claim is covered by the Limited Warranty, we will repair or replace the damaged or defective article and will pay for shipping in both directions. If your warranty claim is not covered by the Limited Warranty, you will be responsible for all shipping costs, and if you elect to proceed with repair, you will be responsible for the cost of repair at our usual rates as then in effect.

## Section 2 - Silhouette Software

### Disclaimer

If the Order Form includes one or more licenses of Silhouette Software, the Silhouette Software is licensed to you “as is” and all representations or warranties (statutory, express or implied except any which may not lawfully be excluded) are expressly excluded. Without prejudice to the generality of the foregoing, the implied warranties of merchantability and fitness for a particular purpose are excluded. You acknowledge that the Silhouette Software operates in a predictive manner relative to input of which AML has no control over the collection, use or interpretation, and you accept the entire risk as to the use and the results of the use of the Silhouette Software in the terms of correctness, accuracy, reliability and performance. You also accept the entire risk as to any conflict between Silhouette Software and other software on the hardware on which the Silhouette Software is installed.

## Part 3: Use of Silhouette Software

### Section 1 - SilhouetteCentral – Customer Hosted

#### Overview

This Section 1 applies if the Order Form includes a license of SilhouetteCentral where data is to be hosted by you on your server.

#### Installation

SilhouetteCentral is supplied by download from the internet or by other means. The software includes installation instructions for a person skilled in computer system administration to carry out the installation process. To assist in this installation, we will provide remote assistance by connecting to the server computer via the internet. You are responsible for coordinating within your organization to have a properly skilled person available at the site while our service person assists with the SilhouetteCentral installation.

Each Image Capture Unit connects to SilhouetteCentral in one of two ways: (1) an indirect connection via a Point of Care Access License that permits an instance of SilhouetteConnect installed on a personal computer, laptop or tablet to communicate with an instance of SilhouetteCentral, or (2) a direct connection via a Point of Care Access License that permits the Image Capture Unit to communicate directly with an instance of SilhouetteCentral. In either case, configuration is required as described below.

#### **Connection via SilhouetteConnect**

Each instance of SilhouetteConnect must be configured to connect with the specific SilhouetteCentral database to allow SilhouetteCentral to synchronize. This configuration is performed by you and all necessary setup information for configuring SilhouetteCentral will be provided to you by us. A Point of Care Access License is required to enable this connection.

ARANZ Medical will provide detailed instructions to you on how to configure an instance of SilhouetteConnect to connect to SilhouetteCentral. ARANZ Medical will provide telephone assistance in the setup of the first license of SilhouetteConnect at no charge. Any requested support for additional licenses of SilhouetteConnect will be considered as support for that license of SilhouetteConnect and processed accordingly.

You are responsible for the setup and maintenance of the connection of each personal computer, laptop or tablet on which SilhouetteConnect is installed to the internet and for ensuring that each instance of SilhouetteConnect is regularly synchronized with SilhouetteCentral. We highly recommend that you synchronize each instance of SilhouetteConnect on each day on which data is collected.

#### **Direct Connection**

Where an Image Capture Unit is connected directly to SilhouetteCentral via a Point of Care Access License, each Image Capture Unit must be configured to access your URL and instance of SilhouetteCentral. This configuration is performed by you and all necessary setup information is provided to you by us. You are responsible for the maintenance and performance (to our product minimum specifications) of your wireless internet connection to allow your Image Capture Unit(s) to communicate with your instance of SilhouetteCentral. Your Point of Care Access License will specify the specific Image Capture Unit(s) which may

connect to an instance of SilhouetteCentral via that Point of Care Access License, and You agree not to circumvent this restriction.

In addition, where the Image Capture Unit is a smart phone or tablet, it is necessary for the user to first download and install SilhouetteLite or SilhouetLite+. We will provide minimum specifications for Your smart phone or tablet, and you are responsible for the purchase and maintenance of the smart phone or table at your expense.

### **System Requirements**

We will provide minimum specifications for the computer system for the server. You are responsible at your expense for the purchase and maintenance of all hardware for the server computer. Note: In smaller installations, for example a wound care center or office, SilhouetteCentral can sometimes be installed on an existing computer in the facility. In larger installations, dedicated higher performance servers will be required.

You are responsible at your expense for the Microsoft software required to support SilhouetteCentral including the operating system and SQL Server database. Note that Microsoft currently provides SQL Server Express Edition at no charge. The Express edition has certain performance and database size limitations and is suitable for smaller installations of SilhouetteCentral.

You are responsible at your expense for all hardware and network infrastructure at your site including any remote locations. This includes any network data connection costs. You are also responsible for security and regular backup of data.

## **Section 2 - SilhouetteCentral – AML Hosted**

### **Overview**

This Section 2 applies if the Order Form includes a license of SilhouetteCentral where data is to be hosted by us.

### **Set up and Use**

SilhouetteCentral with data hosting by AML requires no software installation at your site for the SilhouetteCentral instance. Each Image Capture Unit connects to SilhouetteCentral in one of two ways: (1) an indirect connection via a Point of Care Access License that permits an instance of SilhouetteConnect installed on a personal computer, laptop or tablet to communicate with an instance of SilhouetteCentral, or (2) a direct connection via a Point of Care Access License that permits the Image Capture Unit to communicate directly with an instance of SilhouetteCentral. In either case, configuration is required as described below.

### **Connection via SilhouetteConnect**

Each instance of SilhouetteConnect must be configured to connect with the specific SilhouetteCentral database to allow SilhouetteCentral to synchronize. This configuration is performed by you and all necessary setup information for configuring SilhouetteCentral will be provided to you by us. A Point of Care Access License is required to enable this connection.

ARANZ Medical will provide detailed instructions to you on how to configure an instance of SilhouetteConnect to connect to SilhouetteCentral. ARANZ Medical will provide telephone assistance in the setup of the first license of SilhouetteConnect at no charge. Any requested support for additional licenses of SilhouetteConnect will be considered as support for that license of SilhouetteConnect and processed accordingly.

You are responsible for the setup and maintenance of the connection of each personal computer, laptop or tablet on which SilhouetteConnect is installed to the internet and for ensuring that each instance of SilhouetteConnect is regularly synchronized with SilhouetteCentral. We highly recommend that you synchronize each instance of SilhouetteConnect on each day on which data is collected.

### **Direct Connection**

Where an Image Capture Unit is connected directly to SilhouetteCentral via a Point of Care Access License, each Image Capture Unit must be configured to access your URL and instance of SilhouetteCentral. This configuration is performed by you and all necessary setup information is provided to you by us. You are responsible for the maintenance and performance (to our product minimum specifications) of your wireless internet connection to allow your Image Capture Unit(s) to communicate with your instance of SilhouetteCentral. Your Point of Care Access License will specify the specific Image Capture Unit(s) which may connect to an instance of SilhouetteCentral via that Point of Care Access License, and You agree not to circumvent this restriction.

In addition, where the Image Capture Unit is a smart phone or tablet, it is necessary for the user to first download and install SilhouetteLite or SilhouetteLite+. We will provide minimum specifications for Your smart phone or tablet, and you are responsible for the purchase and maintenance of the smart phone or table at your expense.

### **General**

We will provide instructions on web access to SilhouetteCentral. SilhouetteCentral can be accessed from a Microsoft Windows PC using Microsoft Internet Explorer (version 7 or later) web browser, which you will be required to provide at your expense.

We are responsible for connectivity charges relating to connecting SilhouetteCentral on our server to the internet. You are responsible for any other internet data charges – e.g. if there are charges for the connection of each personal computer, laptop or tablet on which SilhouetteConnect is installed to the internet, and/or for the connection of your Image Capture Unit directly to Silhouette Central via a Point of Care Access License, and for performance and cost of the internet network traffic of any computer system used to access SilhouetteCentral.

We will provide hosting of SilhouetteCentral on the internet and we have sole discretion as to the means of providing this data hosting service (we may host this service on our servers or on third party servers). However we choose to host this service, and provided you comply with the requirements imposed on you under the Section entitled "Security" below, we are responsible for the maintenance and backup of the data transferred to the server hosting SilhouetteCentral.

The SilhouetteCentral server will be off-line for short periods for scheduled (and in some cases unscheduled) maintenance so 100% up-time of the server is not guaranteed. We will back up the SilhouetteCentral server content regularly according to standard industry practice.

### **Security**

We use standard industry practice employed in medical record systems to ensure the confidentiality of data stored on SilhouetteCentral.

You agree to configure SilhouetteConnect and SilhouetteCentral according to guidelines provided by us with regards to maintaining data confidentiality. All information is under username/password protection and you are responsible for selection and modification of all usernames and passwords and for ensuring that the confidentiality of this access information. You agree to allow us to access your instance of SilhouetteCentral for service purposes. You agree that you are responsible for any legal issues (other than our responsibilities with respect to confidentiality and back up described in the previous paragraph) relating to storage of data on SilhouetteCentral.

### **Termination**

You are permitted to terminate your license of SilhouetteCentral only as of the last day of a calendar quarter, by giving us written notice of termination at least 15 days prior to the last day of the quarter, except that where the Order Form specifies a minimum number of quarters, you may terminate your licence only as of or after the last day of the last specified quarter. We will continue to invoice you quarterly for, and you agree that you will continue to pay, Quarterly License Fees for SilhouetteCentral until the effective date of termination of your license.

Following the effective date of termination, including any termination by us pursuant to the terms of the CTEULA or these Terms of Use, we will take SilhouetteCentral off line, archive all images and wound assessment records and provide these to you. (This will be in the form of jpg images, an export of the wound measurement data in CSV (comma separated value) format file, and an export of the Silhouette format data in the event that in future the customer may require this.) A Data Archival Fee will apply to this service. Once this data transfer has occurred, we may, at our discretion, delete all patient data. We reserve the right to provide an alternate means of providing this data hosting service or to discontinue providing SilhouetteCentral at any time; provided, however, that we will not discontinue this service during the period that you have committed to pay hosting fees in the accepted Order Form.

### **Customization**

The software comprising SilhouetteConnect and SilhouetteCentral is standard, and without customization and configuration. Upon Customer request, a customization or configuration service can be made available for an additional charge.

## **Section 3 - SilhouetteConnect**

### **Overview**

This Section 3 applies if the Order Form includes a license of SilhouetteConnect.

### **Installation**

SilhouetteConnect is supplied by download from the internet or by other means, and must be separately installed on each personal computer, laptop or tablet running SilhouetteConnect. The software includes installation instructions for a person skilled in computer system administration to carry out the installation process.

### **System Requirements**

We will provide minimum specifications for the personal computer(s), laptop(s) and/or tablet(s) running SilhouetteConnect. You are responsible at your expense for the purchase and maintenance of the personal computer(s), laptop(s) and/or tablet(s). You are responsible at your expense for all other hardware and network infrastructure at your site including any remote locations, and for any network data connection costs. You are also responsible for security and regular backup of data.

### **Input/output Unit and Other Limitations**

Each license of SilhouetteConnect is restricted to use only on a single personal computer, laptop or tablet. You agree not to exceed this limitation. Where an instance of SilhouetteConnect is not integrated to connect to an instance of SilhouetteCentral, a maximum of 2000 assessments (or other number of assessments specified in the Order Form) may be stored with that instance of SilhouetteConnect. Where that limit is exceeded, you must either purchase an additional license of SilhouetteConnect or a license of SilhouetteCentral.

## **Part 4: Technical Support Policies**

These Technical Support Policies apply to technical support (**Support**) that we provide for the Silhouette Software:

- SilhouetteCentral
- SilhouetteConnect

### **Support Contracts**

Each licence of the Silhouette Software will only be entitled to Support during periods that license is under a current Support Contract. You will not be entitled to Support or Updates for any license of Silhouette Software for which a Support Contract is not purchased. Three levels of Support are offered under different Support Contracts: Minimum Support, Enhanced Support and Premium Support. Unless otherwise provided in an accepted Order Form, if your license is an annual license or is for a shorter Fixed Term, a Support Contract providing Minimum Support is included in the license fees charged for the Fixed Term (or any offered and accepted Renewed Term); provided, if you wish to purchase Enhanced Support or Premium Support for that license, additional fees apply. Unless otherwise provided in an accepted Order Form, if your licence is for a Continuous Term, your license fee will not include a Support Contract. In the case of a license for a Continuous Term, (1) you will not be entitled to Support or Updates unless you purchase a Support Contract for each applicable Support period, at our then current rates, (2) the Support period (usually one year) will be the period for which we have invoiced and you have paid support fees in advance, (3) you will not be required to pay Support fees, but you acknowledge that without Support and Updates the functionality of the Silhouette Software will not progress and may degrade over time, and (4) you may purchase a Support Contract at one of our three offered levels: Minimum Support, Enhanced Support or Premium Support. Further if you and/or a related person or entity holds more than one licence of the Silhouette Software, you or they will not be entitled to Support unless a current Support Contract is maintained on all such licences.

### **Provision of Support**

Support is provided through email and telephone during the Support hours designated in your Support Contract. We will provide you with a telephone number and email address for you to use in seeking Support. You are responsible for all telecommunications charges (telephone, internet, etc.) you incur in contacting us for Support. If a voicemail answers your call or you do not receive a response to your email request during your business hours, we will endeavor to respond within the applicable response time designated in your Support Contract. The person contacting us for Support on your behalf must be knowledgeable about the relevant Product and your environment in order to assist us in analyzing and resolving service requests, and must have a baseline understanding of the problem you are encountering and an ability to reproduce the problem in order to assist us in diagnosing and triaging the problem.

### **Scope of Support**

Support that we provide is remote assistance with technical questions about the Products. It also includes Updates as defined below. The scope of Support (whether Minimum, Enhanced or Premium) is designated in your Support Contract. Regardless of the level of Support purchased by you, Support does not include the following Services: training, product integration, project integration, project implementation, consulting, data review, data processing, data correction or user administration services, data archival services, but these Services may be available for additional fees either directly by us or through our distributors or agents. Support and Services are delivered in English only.

### **Updates and Modules**

Updates with respect to the Silhouette Software may be offered from time to time. Updates of our Silhouette Software Products are offered to license holders of those Products if your license is in effect, with a current paid Support Contract in effect, during the period the release is first offered. Updates and installation instructions are made available by download and you will be responsible for copying, downloading and installing the Updates. If we offer you an Update, but you do not accept it, we will have no obligation to provide Support of older versions. We may offer you Modules from time to time, subject to your payment of any additional license fees and agreement to any terms and conditions applicable to the Module. All Updates accepted by you and all Modules purchased by you will form a part of the Silhouette Software licensed to you and be subject to these Terms of Use and the CTEULA.

### **Lapsed Support**

If Support lapses because you have failed to purchase a Support Contract prior to the commencement of an offered Support period, and you subsequently wish to be reinstated in the Support program, you must:

- a) pay all support fees that would have been payable during the period Support was lapsed had you kept a Support Contract in place on a continuous basis.
- b) update your Silhouette Software to the latest major release.

### **Discontinuation of Support**

We may choose to discontinue Support of any of our Silhouette Software Products (or any release thereof) at any time in the future; however, if your licence is for a Continuous Term we will continue Support for a minimum period of three years from the date of your original purchase of your licence for a Continuous Term, so long as you have purchased a Support Contract for all Support periods during such three year period and have installed all Updates we have offered to you

### **Use of Information**

You recognize that in the course of receiving Support, you or your representatives may furnish data or other information to us or to our distributors or support agents. By furnishing such information you irrevocably consent to the use, transfer and processing of this information by us, our distributors and agents for support purposes and keeping you apprised of Support and Update information.

### **Contact Us**

We value your business and want you to experience success with Silhouette. If for any reason you are not satisfied with the Support you receive, please contact us at [quality@aranzmedical.com](mailto:quality@aranzmedical.com).

## **Part 5: General Terms**

The Products are supplied with the user interface and supporting documentation in English only.

We may perform any of our obligations under these Terms of Use through a distributor or agent.

These Terms of Use are subject to revision by us at any time, provided we will provide you with advance written notice of any such revisions.

Terms of Use Document Number: 2011-00017, Revision: 3.0